

ENGLISH

CONTENTS

1. INTRODUCTION	3
2. WARNINGS & CAUTIONS	3
3. V100A ILLUSTRATIONS	
HEAD UNIT	4
COMPONENT ILLUSTRATIONS	5
4. BUTTON FUNCTIONS	
SETUP MODE	7
OPERATING MODE	7
5. V100A SCREEN DISPLAY SEQUENCE: BI-LEVEL MEMORY	8
6. V100A PRIMARY FUNCTIONS	
UPPER SCREEN MODES	
Speed, Trip Distance, Ride Time, Total Time	10
Average Speed, Maximum Speed	11
Speed*, Cadence*	12
LOWER SCREEN MODES	
Altitude, Percent Grade	12
Total altitude, Maximum Altitude, Clock, Odometer	13
Speed, Temperature, Stopwatch, Intermediate Distance	14
Stopwatch, Intermediate Altitude	15
Dual Bike Memory	16
7. V100A SECONDARY FUNCTIONS & FEATURES	
Maximum & Minimum Temperature	16
Average Cadence*, Maximum Cadence*, Maximum Percent Grade-Climbing, Maximum Percent Grade-Descending	17

V100A

Service Timer, Low Battery Alert, Speed Comparator	18
Freeze Frame Memory	19
AUTO START	20
SLEEP MODE	20
RIDE DATA RESET	21
ALL CLEAR TOTAL RESET	21
8. BATTERY INSTALLATION	
HEAD UNIT	22
WL WIRELESS SPEED TRANSMITTER	23
9. SETUP MODE & PROGRAMMING	24
10. PRE-RIDE ALTIMETER CALIBRATION SETUP	36
11. INSTALLATION	
WIRED MODEL INSTALLATION	
Speed Sensor & Magnet	41
Mounting Bracket	44
Head Unit	45
WIRELESS MODEL INSTALLATION	
Speed Transmitter & Magnet	46
Active Mount	49
Head Unit	51
INSTALLATION TESTS	52
12. TROUBLESHOOTING	
PROBLEM/ITEMS TO CHECK/SOLUTION	53
13. TECHNICAL SPECIFICATIONS	55
14. WARRANTY POLICY	
REQUIREMENTS FOR WARRANTY SERVICING	57
ITEMS TO BE INCLUDED IN RETURNS	58

The logo features a large, bold, black 'V' on the left. To its right, the numbers '100' and the letter 'A' are rendered in a white, outlined, sans-serif font. A solid black horizontal line extends from the right side of the 'A' across the bottom of the page.

INTRODUCTION

Thank you for purchasing a Vetta V100A cycle computer. The V100 series computers represent the latest evolution in Vetta's computer line and are designed for cycling enthusiasts and competitive cyclists alike. In particular, the V100A model offers a wide range of unique features and functions such as Altitude, Temperature, Dual Bike Memory, Intermediate Altitude and Distance, Stopwatch readings and a Service Timer. Please take time to familiarize yourself with all the functions of the V100A model so you can take full advantage of its programs. And don't forget to store this manual in a safe place for future reference!

WARNINGS & CAUTIONS

- Vetta cycle computers are sophisticated electronic instruments. Vetta recommends that this product be installed only by a qualified bicycle retailer. Failure to read these instructions and/or improper installation of this device may void the warranty. If in doubt about any aspect of the installation or operation of this product, consult your local bicycle retailer for clarification.
- The V100A cycle computer is a general indicator of altitude; it is not suitable or intended for any use other than cycling. Elevation and Percent Grade values displayed by the V100A altimeter may be subject to slight fluctuations due to changes in barometric pressure readings taken by the unit's pressure sensor. Such changes, attributed primarily to variations in temperature and weather, may affect the accuracy of this instrument.
- The head unit is water resistant and sealed to withstand wet weather conditions. However, do not deliberately place it in water.
- Avoid leaving the head unit exposed to extremely hot or cold weather conditions.

- Vetta encourages you to ride safely. Wear a helmet every time you ride, use front and rear lights at night, and always keep your eyes on the road ahead of you.

V100A ILLUSTRATIONS

HEAD UNIT: FRONT

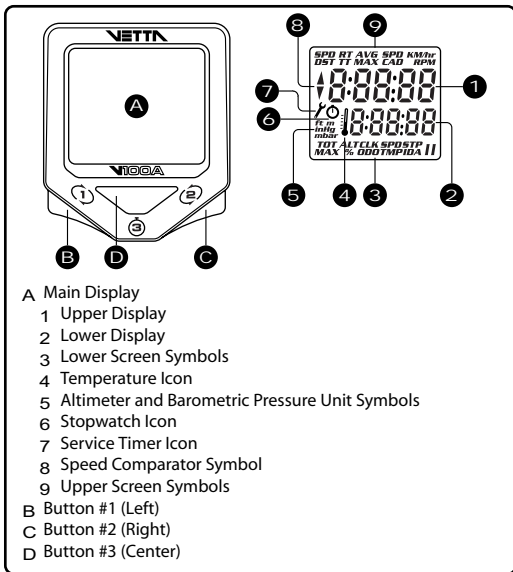

HEAD UNIT: REAR

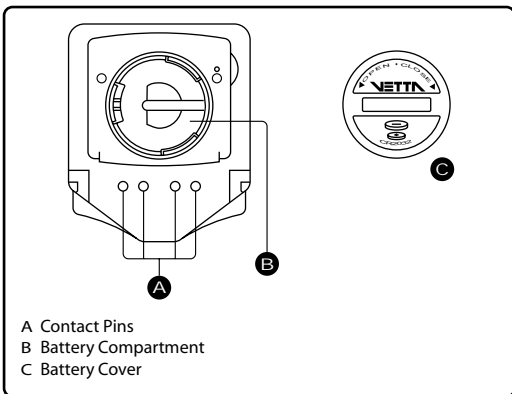

COMPONENT ILLUSTRATIONS

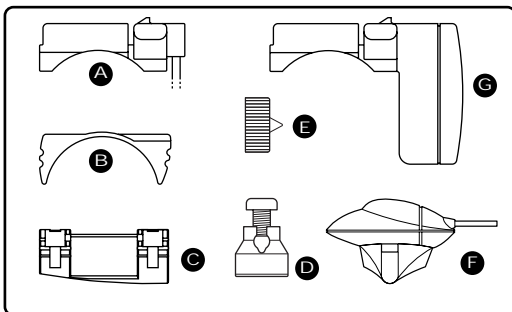

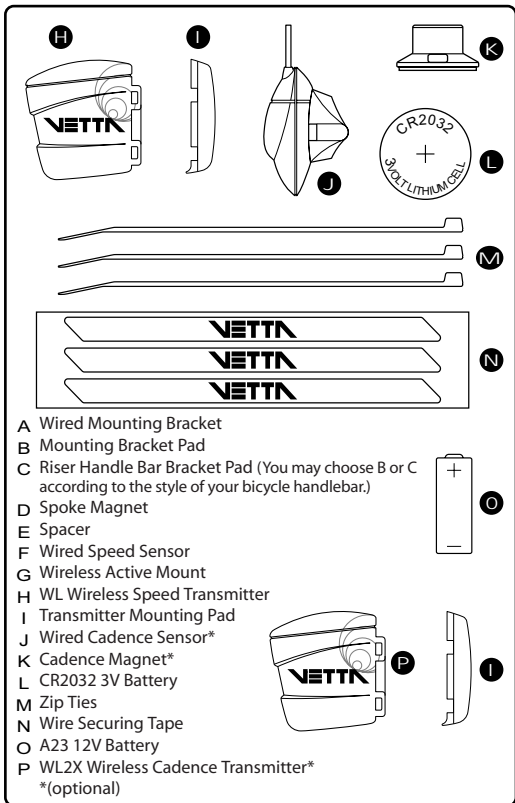

BUTTON FUNCTIONS

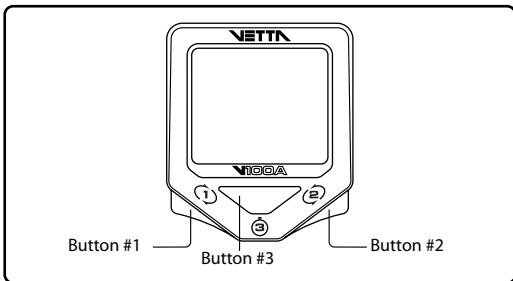

SETUP MODE

- Button #1 Sets digits or units and advances to the next item or screen.
- Button #2 Advances digits and toggles through units. Hold for fast advance.
- Button #3 Has no function in Initial Setup.

NORMAL OPERATING MODE

- Button #1 Scrolls through lower level screen symbols and Freeze Frame display screens.
- Hold 2 seconds in Temperature mode (SPD/TMP) to display Maximum and Minimum Temperature.
 - Hold 2 seconds in SPD/CAD* screen to display Average and Maximum Cadence.
 - Hold 2 seconds in ALT/% screen mode to display Max % uphill grade and Max % downhill grade.
 - Hold 2 seconds in STP/ID screen mode to switch to STP/IA screen mode, or hold 2 seconds in STP/IA screen mode to switch to STP/ID screen mode.
- *(optional)

- Button #2** Scrolls through upper level screen symbols. Press and hold 2 seconds in any primary screen mode to activate Freeze Frame memory. Resets RT to zero for Service Timer.
- Button #3** Starts and stops the timers and Stopwatch and is used to reset timers, Stopwatch and other ride data to zero. Exits Normal Operating Mode (NOM) Setup and advances to NOM System Check and SPD/DST screen mode.
- Buttons 1&2** With RT/TT timers turned OFF, hold both buttons simultaneously for 2 seconds in the SPD/DST primary screen to enter NOM Setup for bicycle functions. Hold simultaneously for 2 seconds in the ALT/% screen to enter Pre-Ride Altimeter Calibration Setup.

V100A SCREEN DISPLAY SEQUENCE: BI-LEVEL MEMORY

The V100 series computers are programmed with a Bi-Level Memory which returns to the last screen function accessed between the upper and lower screen modes. See illustration for this sequence and instructions on how to advance from one screen to the next.

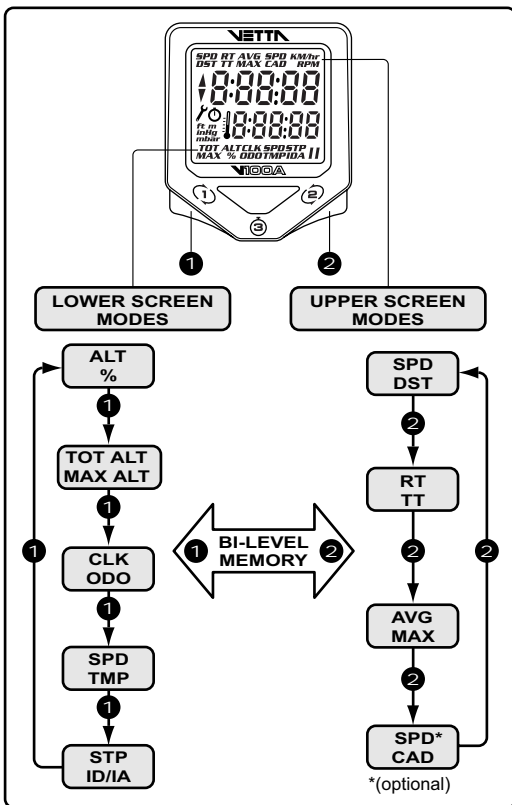

V100A PRIMARY FUNCTIONS

UPPER SCREEN MODES

SPEED

SPD

TRIP DISTANCE

DST



SPD displays the current Speed and is updated continuously. DST displays the current Trip Distance and automatically resets after the maximum trip distance (999.9) is achieved. Trip distance is displayed in the SPD/DST screen mode and starts automatically when the wheel rotates and TT Timer is active. **Reset DST to zero by pressing Button #3 for 2 seconds with the timers turned off in any screen mode except STP/ID or STP/IA.**

RIDE TIME

RT

TOTAL TIME

TT

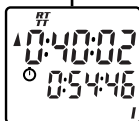

Ride Time and Total Time functions are shown simultaneously. Ride Time (RT) measures actual riding time and starts automatically when the timers are set to "0:00:00" and the wheel rotates. Total Time (TT) shows the total elapsed trip time from start to finish. Like RT, TT starts automatically when the wheel rotates **ONLY** when the timers are set to "0:00:00", or it can be started manually by pressing Button #3 in the RT/TT screen mode **ONLY**. TT can only be stopped manually by momentarily pressing Button #3 in the RT/TT screen mode at the end of a ride. To reset both RT and TT to zero, turn the timers off and press Button #3 for at least 2

seconds. **Note:** Whenever TT is activated, the stopwatch icon appears; otherwise it does not appear. The TT Timer must be active in order for the RT Timer to accumulate Ride Time and for the computer to calculate current ride data.

CAUTION: If RT and TT timers are not 0:00:00 and you have stopped them manually, then they **MUST** be restarted manually by pressing Button #3 in the RT/TT mode. If not, the computer will not record speed or other ride data. RT and TT timers can be manually activated or deactivated only from the RT/TT screen mode.

Riding Tip: If the bike is in motion and Button #3 is held down in the RT/TT screen mode with the timers deactivated, the ride timers reset to 0:00:00. When Button #3 is released, both RT and TT will start with the next wheel input. This is a good way to begin timing a race or training ride with a rolling start.

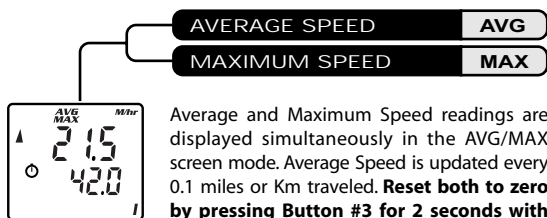

Average and Maximum Speed readings are displayed simultaneously in the AVG/MAX screen mode. Average Speed is updated every 0.1 miles or Km traveled. **Reset both to zero by pressing Button #3 for 2 seconds with timers turned off in any screen mode except STP/ID or STP/IA.**



When installed, the Cadence kit measures and displays pedal Cadence in Revolutions Per Minute (RPM). The SPD/CAD screen function letters appear **ONLY** when the Cadence hardware is installed and a Cadence signal received by the head unit. After a current ride data reset, (Button #3 for 2 seconds with the timers off) the function letters will disappear, but they will come back on with the next Cadence input. **Note:** RT and TT timers **MUST** be activated in order for Speed and Cadence to function.

*(optional)

LOWER SCREEN MODES

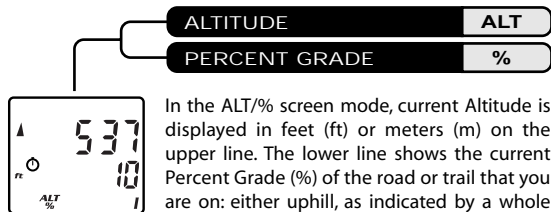

In the ALT/% screen mode, current Altitude is displayed in feet (ft) or meters (m) on the upper line. The lower line shows the current Percent Grade (%) of the road or trail that you are on: either uphill, as indicated by a whole number, or downhill, indicated by a number preceded by a minus sign (-). **Note:** A secondary screen that displays your Maximum % upgrade (climbing) and Maximum % downgrade (descending) can be displayed by pressing Button #1 for 2 seconds in the ALT/% screen mode.

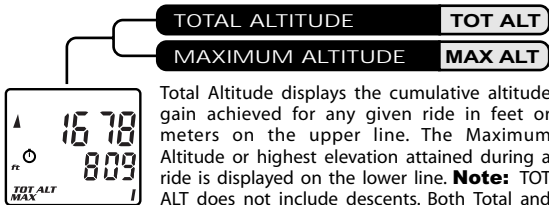

Total Altitude displays the cumulative altitude gain achieved for any given ride in feet or meters on the upper line. The Maximum Altitude or highest elevation attained during a ride is displayed on the lower line. **Note:** TOT ALT does not include descents. Both Total and Maximum Altitude readings can be cleared by pressing Button #3 for 2 seconds with the timers turned off in any primary screen except STP/ID or STP/IA.

CAUTION: Whenever you clear ride data between rides or during a ride, you must recalibrate your Altimeter before you start riding again. Otherwise the Altimeter will not function.

Riding Tip: Before you clear ride data (especially during a ride), always check your "current" altitude reading so you will know your present elevation when you recalibrate your altimeter. To recalibrate properly and most accurately, you need to know either your exact current altitude or the current barometric pressure at sea level for your locale.

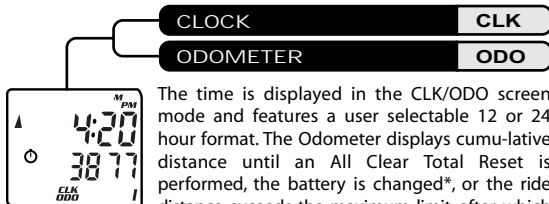

The time is displayed in the CLK/ODO screen mode and features a user selectable 12 or 24 hour format. The Odometer displays cumulative distance until an All Clear Total Reset is performed, the battery is changed*, or the ride distance exceeds the maximum limit, after which the Odometer will automatically reset to zero. ***Note:** Odometer reading can be reinstalled by user after a battery change.

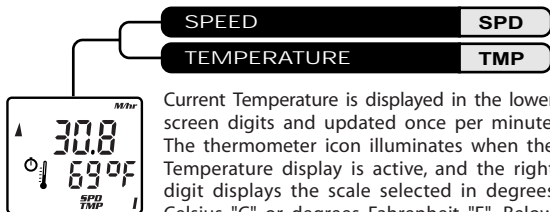

Current Temperature is displayed in the lower screen digits and updated once per minute. The thermometer icon illuminates when the Temperature display is active, and the right digit displays the scale selected in degrees Celsius "C" or degrees Fahrenheit "F". Below zero readings are indicated by a minus sign (-).

Note: A secondary screen displays Maximum and Minimum Temperatures on the upper and lower lines respectively. Press and hold Button #1 for 2 seconds to access the Max/Min TMP screen. Press Button #1 again to return to the SPD/TMP primary screen.

Note: The temperature reading can sometimes vary due to the computer head unit being heated by direct sunlight; which can heat the case hotter than the actual air temperature.

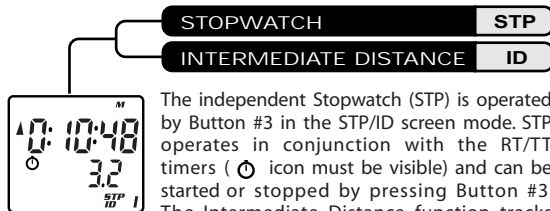

The independent Stopwatch (STP) is operated by Button #3 in the STP/ID screen mode. STP operates in conjunction with the RT/TT timers (⌚ icon must be visible) and can be started or stopped by pressing Button #3. The Intermediate Distance function tracks an intermediate distance within a longer ride. ID does not affect overall Trip Distance or current ride data, but it operates the same as the DST function. From the STP/ID screen mode with timers active, press Button #3 to start

Stopwatch and ID functions; press Button #3 again to stop functions and freeze data for review. Reset Stopwatch, Intermediate Distance and Intermediate Altitude to zero by pressing Button #3 for 2 seconds.

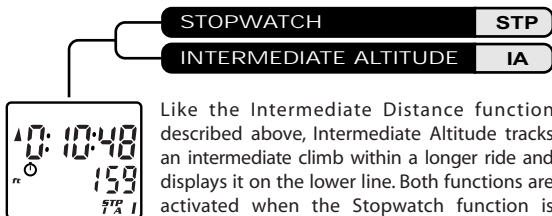

Like the Intermediate Distance function described above, Intermediate Altitude tracks an intermediate climb within a longer ride and displays it on the lower line. Both functions are activated when the Stopwatch function is engaged. To switch from the STP/ID screen to the STP/IA screen and back again, press Button #1 for 2 seconds. Intermediate Altitude does not affect Total Altitude data, but it operates the same as the TOT ALT function. From the STP/IA screen and with the RT/TT timers active, press Button #3 to start the Stopwatch and the Intermediate Altitude functions running; press Button #3 again to stop the functions and freeze the data for review. Reset Stopwatch and both Intermediate Distance and Altitude to zero by pressing Button #3 for 2 seconds.

DUAL BIKE MEMORY

I II



The V100A can be calibrated for two bicycles. It will store separate Wheel Size, Service Timer, Odometer and Altitude settings, as well as different formats selected for Time, Temperature, Speed and Distance. The current bike number (I or II) is always displayed in the lower right corner of the screen. To switch the computer quickly from Bike I to Bike II, go to the first screen in the Normal Operating Mode Setup program. (See SETUP section below for details.)

V100A SECONDARY FUNCTIONS & FEATURES

MAXIMUM & MINIMUM TEMPERATURE



To display both the Maximum and Minimum Temperature readings, press and hold Button #1 for 2 seconds in the Temperature SPD/TMP screen mode. **Note:** The screen will flash to indicate that the computer is displaying data in a secondary screen. To return to the primary SPD/TMP screen mode, press Button #1 again. When ride data is reset by holding Button #3 with the timers stopped, both Maximum and Minimum Temperatures reset to the current Temperature.

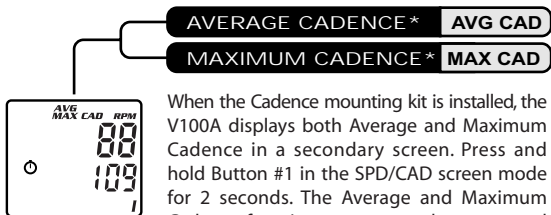

When the Cadence mounting kit is installed, the V100A displays both Average and Maximum Cadence in a secondary screen. Press and hold Button #1 in the SPD/CAD screen mode for 2 seconds. The Average and Maximum Cadence functions appear on the upper and lower lines respectively. Press Button #1 once again in order to return to the primary SPD/CAD screen. *(optional)

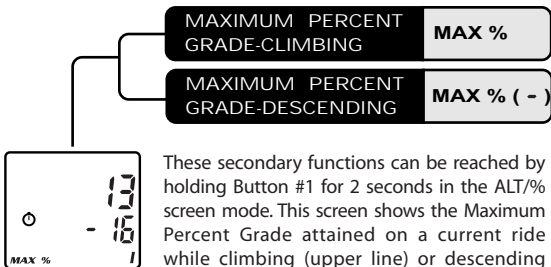

These secondary functions can be reached by holding Button #1 for 2 seconds in the ALT/% screen mode. This screen shows the Maximum Percent Grade attained on a current ride while climbing (upper line) or descending (lower line). The percent grade for descents is preceded by a minus sign (-). **Note:** This screen will flash to indicate that the computer is displaying data in a secondary screen. Press Button #1 again to exit to the ALT/% primary screen.

SERVICE TIMER

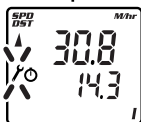

Alerts rider when Ride Time reaches a preset limit for a maintenance check on the bike or any main component. Suspension forks, rear shocks, chains, etc. require service at specific time intervals set by manufacturers. Vetta's Service Timer allows the rider to preset an exact number of riding hours during Setup, then signals (slow, flashing wrench icon) when the service time limit has been reached. (See SETUP section below for details.)



LOW BATTERY ALERT



The V100A Service Timer icon has been programmed to signal low battery power in the head unit. When the battery runs low and needs to be replaced, the Service Timer icon () will illuminate and stay "on" (no blinking). Replace the head unit battery as soon as possible. Rapid blinking of the Service icon indicates both low battery power and expiration of the preset service time interval.

SPEED COMPARATOR



The Speed Comparator symbols on the left side of the display screen indicate whether current Speed is above or below current Average Speed. A positive () or negative () symbol appears in the upper left part of the screen in all primary screen modes. The Speed Comparator symbols do not appear if Speed (SPD) and Average Speed (AVG) are the same.

FREEZE FRAME MEMORY

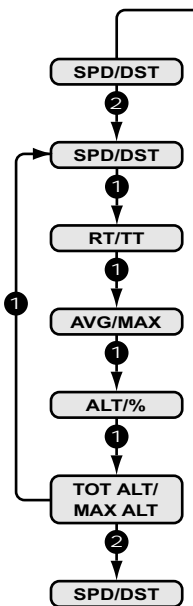

Freezes ride data from 5 primary screens for review at any point during a race or training ride. To activate Freeze Frame, press and hold Button #2 for 2 seconds in any primary screen mode. The screen will flash to indicate it has been frozen. The computer will continue to record ride data. Advance through the frozen screens by pressing Button #1 repeatedly. Press Button #2 to cancel Freeze Frame and return to the previous screen mode.

Note: If the Altimeter is turned OFF, Freeze Frame will display only 3 primary screens: SPD/DST, RT/TT and AVG/MAX.

Note: If Ride Time/Total Time (RT/TT) is not running at the time Freeze Frame is activated (Button #2 for 2 seconds), then previously frozen ride and altitude data will be displayed. At the end of the ride, user can view both "end-of-ride" data (by stopping the timers and toggling through the frozen primary screens) and the last Freeze Frame data screens recorded (by activating Freeze Frame with the RT/TT timers turned

AUTO START

If the RT/TT ride timers read zero (0:00:00), the Vetta V100A computer automatically starts as soon as it receives input from the wheel. The RT and TT timers are activated and other ride data begins to accumulate (SPD, DST, AVG & MAX SPD, CAD*, AVG & MAX CAD*, ODO, TOT ALT and %).

Note: Any time the timers are stopped manually and they are not cleared, RT and TT must be restarted manually by pushing Button #3 in the RT/TT screen mode.

*(optional)

SLEEP MODE

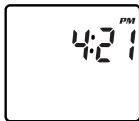

To conserve battery life, the V100A computer is programmed to enter a Sleep Mode after receiving no input from buttons, wheel motion or cadence for 5 minutes. In this mode the V100A screen displays only the time of day. **The computer exits Sleep Mode automatically, in the wired version only, when it receives input from buttons or wheel/crank motion and returns to the screen last displayed. In the wireless version the computer will "wake up" only when one of the buttons is pushed.** The Altitude sensor will "read" new altitude as soon as the computer exits from Sleep Mode. Clock, Stopwatch and Total Time (for the ride) continue to run during the Sleep Mode.

RIDE DATA RESET

To reset current ride, Freeze Frame and Altitude data to zero (DST, RT, TT, AVG & MAX SPD, AVG & MAX CAD*, TOT & MAX ALT, MAX % & MAX % (-), MAX & MIN TMP, STP, ID and IA), make sure the timers (RT/TT) are turned OFF and press Button #3 for 2 seconds in any primary screen mode except STP/ID or STP/IA.

WARNING: The Altimeter must be re-calibrated after any ride data reset and before the next ride. See the section on Altimeter Calibration Setup below. *(optional)

ALL CLEAR TOTAL RESET

All settings entered in Initial Setup, as well as all accumulated ride data, can be cleared by performing an All Clear Total Reset. To clear the computer, press all three buttons simultaneously and hold for 5 seconds in any screen mode. When the computer is cleared, the master screen will appear and show all LCD segments for 3 seconds. The computer will then automatically enter Initial Setup mode to be reprogrammed.

Note: Both Initial and Normal Operating Mode Setup utilize the same sequence of Setup screens. Initial Setup is activated after a battery installation or change, or after an "All Clear Total Reset" has been performed. All units and values must be (re)entered during Initial Setup. The Normal Operation Mode Setup program allows the user to change or correct any value or units easily. To access NOM Setup, press and hold Buttons #1 and #2 for 2 seconds in the SPD/DST screen mode. Scroll to the value you wish to change quickly by pressing Button #1 successively.

BATTERY INSTALLATION

HEAD UNIT

The V100A head unit uses a CR2032 3V lithium button cell battery. **IMPORTANT: Most cycle computer problems are caused by weak or dead batteries. See the Troubleshooting section near the end of this manual for details.**

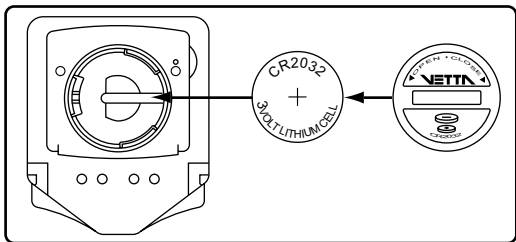

- Step 1:** Remove the battery cover from the bottom of the computer using a coin. Remove the old battery.
- Step 2:** Install a new battery as shown with the positive (+) side facing out. Do not touch or bend any of the battery contacts during installation.
- Step 3:** Screw the battery cap firmly into place making sure the o-ring seal does not get pinched or distorted.

CAUTION: To avoid damage to the battery cap, do not over tighten.

WL WIRELESS SPEED TRANSMITTER

The V100A WL wireless speed transmitter (signal from the wheel) uses an A23 12V battery. Remove cap, install battery with positive (+) side up, replace battery cap. **CAUTION: Make sure the transmitter battery cap is properly installed to insure good signal transmission.** Be sure to align the "CLOSED" dot on the battery cap with the "CLOSED" dot on the transmitter housing when you reinstall the cap.

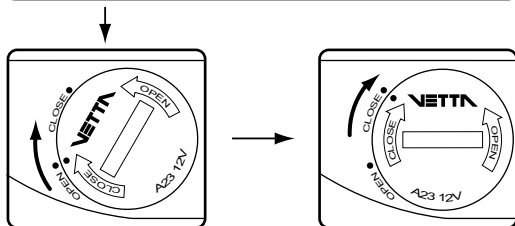
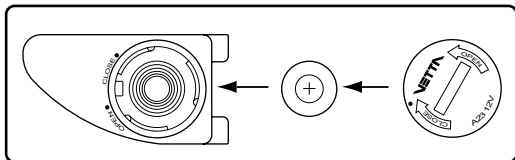
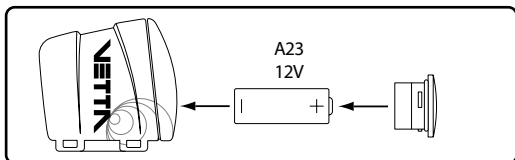

SETUP MODE & PROGRAMMING

INTRODUCTION

After battery installation, the master screen will appear briefly and the computer will automatically go into the Initial Setup program mode. **Note: To enter Setup when in the Normal Operating Mode (NOM), go to the SPD/DST screen mode and press Buttons #1 and #2 simultaneously for 2 seconds with the RT/TT timers off. Exit NOM Setup mode by pressing Button #3.**

Both the Initial and NOM Setup modes allow the rider to select operational units and values for the computer function displays. All the steps in the Initial Setup mode have been pre-programmed. If an entry error is made, complete the Initial Setup program and then re-enter Setup from the Normal Operating Mode as described above to revise the setting.

In both Initial and Normal Operating Mode Setup, press Button #2 to toggle between possible unit settings, such as M/hr and KM/hr. Press Button #1 to select a unit or value and advance to the next digit or screen. Press Button #3 at any time to exit NOM Setup and go directly to System Check. **Note:** If no buttons are pressed for approximately 5 minutes during Setup, the computer will automatically enter Sleep Mode and then return to the screen last displayed when reactivated.

SETUP: BIKE I & BIKE II

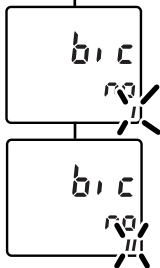

In the Initial Setup mode, after the master screen stops flashing, the screen displays the letters "bic no". The default setting is Bike "I". To toggle between Bike I and Bike II settings, press Button #2. With Bike "I" icon flashing, press Button #1 to select it and advance to the next Setup screen. **Note:** When programming a second bike in Initial Setup, scroll to "II", select it, and advance as instructed above. The V100A computer will retain the values and settings entered for Bike II independently of Bike I.

SETUP: ALTITUDE UNITS

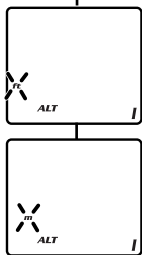

After the bike number has been selected, the Initial Setup program automatically advances to the Altitude Units Setup screen. The default setting for Altitude units is feet (ft). To confirm you want to see altitude readings in feet, press Button #1 to select that value and advance to the next Setup screen. To choose meters (m) instead as the unit of altitude you wish to use, press Button #2 to toggle to that value ("m" will flash), then press Button #1 to select it and advance.

SETUP: ALTIMETER ON/OFF

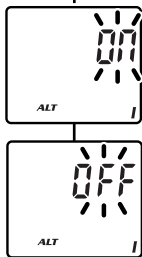

This Setup screen allows you to turn the Altimeter function "ON" or "OFF" as you choose. The default setting for the Altimeter is "ON". Press Button #1 to select Altimeter "ON" and advance to the next screen. Or, if you don't want to activate the Altimeter function, press Button #2 to toggle to the "OFF" setting and press Button #1 to select it and advance. **Note:** If the user selects Altimeter "OFF", the Initial Setup program will skip the Altimeter Memory programming steps below and automatically advance to the Wheel Size Setup screen.

SETUP: ALTIMETER MEMORY 1 & 2



After Altimeter "ON" is selected, the computer advances to Altimeter Memory 1 Setup. This is the first of two Altimeter Memory settings in which the user can enter known elevation values to serve as quick, pre-ride Altimeter calibrations. When a rider frequently starts his or her ride from home or another location with a known elevation, the Altimeter Memory feature enables them to recalibrate the computer quickly and easily at the start of a ride. **Note: The Altimeter must be recalibrated every time the rider begins a new ride by accessing the Pre-Ride Altimeter Calibration Setup through the Normal Operating Mode (NOM) (Press and hold Buttons #1 and #2 for 2 seconds in the ALT/% screen mode).**

In the Initial Altimeter Memory 1 Setup screen, the display shows 5 zeros (00000) on the upper line with the right digit flashing. Press Button #2 to toggle to the desired number for the elevation you intend to set and press Button #1 to select it and advance to the next digit. Continue to use Button #2 to advance the digits from "0" to "9" as needed to set a specific elevation. **Note:** To set a negative, below sea level elevation, the rider must enter a minus sign (-) at the front of the elevation reading and select it by pressing Button #1. **Note:** The default elevation value for both Memory 1 and Memory 2 is "00000" or sea level. The largest possible positive elevation value is "99999" feet or meters. The largest possible negative elevation value is "-9999" feet or meters.



When programming Altimeter Memory 1, the number "1" appears just below the elevation figures (see illustration). When all the values for Altimeter Memory #1 have been set, press Button #1 to select it and advance to Altimeter Memory 2 setting. In this screen the number "2" appears on the lower display line. To program a second elevation into Altitude Memory, proceed as described above for Memory 1. When the last digit for Altimeter Memory 2 elevation has been set, press Button #1 to select it and advance to Initial Wheel Size Setup screen.

WHEEL SIZE CALCULATION

The circumference of the wheel is measured and entered in millimeters. Bike I and II wheel sizes are set independently, and both default to **2074mm** (700c x 20 or 26 x 2.0). The following chart lists the circumference measurements for the most common wheel sizes. To use this chart, find your tire size and record the corresponding circumference measurement.

TIRE SIZE	CIRC	TIRE SIZE	CIRC
700c x 38mm	2180	27" x 1-1/4"	2161
700c x 35mm	2168	27" x 1-1/8"	2155
700c x 32mm	2155	26" x 2.25"	2115
700c x 30mm	2145	26" x 2.1"	2095
700c x 28mm	2136	26" x 2.0"	2074
700c x 25mm	2124	26" x 1.9"	2055
700c x 23mm	2105	26" x 1.75"	2035
700c x 20mm	2074	26" x 1.5"	1985
700c Tubular	2130	26" x 1.25"	1953
650c x 23mm	1990	26" x 1.0"	1913
650c x 20mm	1945	20" x 1-1/4"	1618

If your wheel size is not on the chart, or if you want a more precise calibration, wheel circumference may be calculated as follows:

Step 1: Measure the distance from the center of the front wheel axle to the ground in millimeters. (1 inch = 25.4mm)

Step 2: Multiply this distance by 6.2832 (2π) and enter the result as the wheel size setting into the computer.

OR Mark the tire and a spot on the floor. Roll the wheel forward one complete revolution until the tire mark touches the floor again and mark that spot. Measure the distance between the marks on the floor in millimeters and enter the result into the computer.

SETUP: WHEEL CIRCUMFERENCE

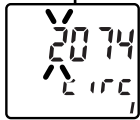
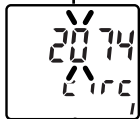
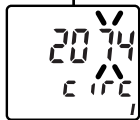
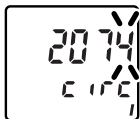

After Altimeter Memory 1 & 2 values have been selected and the display advances to the Wheel Size Setup screen, the letters "circ" appear on the lower level and the default numbers **2074** appear on the upper level with the right digit "4" flashing.

Step 1: To enter a specific wheel size, press Button #2 to advance the flashing digit to the desired number.

Step 2: When the correct number is reached, select it by pressing Button #1. The next digit to the left will start flashing.

Step 3: Press Button #2 to advance the flashing digit to the next desired number in the sequence and press Button #1 once again to select it and advance. Repeat this procedure until all four digits are selected. The computer will automatically advance to the Service Timer Setup screen.

SETUP: SERVICE TIMER

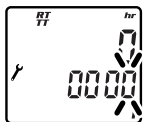

The Service Timers, one for each bike, may be programmed with a select number of ride time hours as the interval for servicing the bicycle or any component on it, such as a front or rear shock. Accumulated Ride Time is displayed on the upper line and the Service Time interval is set and displayed on the lower line. In the Service Timer Interval Setup mode, the hour digits appear on the lower level with the right hand digit flashing. **Note:** The default setting for the Service Timer is "0000" hours, which means the Service Timer is turned off.

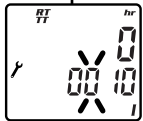
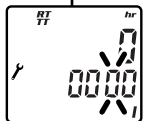

Step 1: To set a service interval (in hours only) scroll to the first digit of the number you want to set using Button #2 and select it by pressing Button #1. **Note:** The Service Timer sets and displays whole hours only. It does not display minutes.

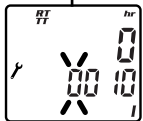

Step 2: Proceed until all the digits for the service interval have been selected, then press Button #1 again. (1999 hours = maximum)

SERVICE TIMER NOTES

- Accumulated Ride Time (upper line) operates in conjunction with the other timers and starts as soon as the wheel turns. It stops automatically when the computer receives no input from the wheel for 3 seconds.
- The Service Timer screen can be viewed in both the NOM Setup mode and in the System Check screen sequence. Access NOM Setup through the SPD/DST screen mode by pressing Buttons #1 and #2 simultaneously for 2 seconds with RT/TT timers off.

- To stop the Service Timer icon from flashing: A) Reset the accumulated Ride Time hours (upper line) to zero "0" through the NOM Setup sequence. The Service Timer interval may also be reprogrammed at this point. B) Change TT setting to a number larger than accumulated RT. C) Set TT to zero "0000" (disable the Service Timer).
- The Service Timer option can be disabled in Initial or NOM Setup mode by entering and selecting a value of zero "0000" hours as the service time interval (lower line).
- After user sets or resets the service time interval in NOM Setup, accumulated Ride Time digits (upper level) will start blinking (as shown in illustration below). Press Button #2 for 2 seconds to reset RT digits to zero. Press Button #3 to exit to the NOM System Check. Press Button #3 again to return to the SPD/DST primary screen.

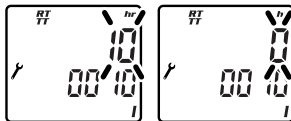

SETUP: SPEED UNITS

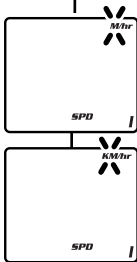

The "M/hr" symbol will appear on the screen with the letter "M" flashing. To select miles per hour as the unit of speed, press Button #1. To scroll to kilometers per hour, press Button #2 and "KM/hr" will appear with the letters "KM" flashing. Press Button #1 to select and advance.

Note: If "M/hr" is selected as the unit of speed, then miles (m) is automatically set as the unit of distance. If "KM/hr" is selected, then kilometers (Km) is automatically set as the unit of distance.

SETUP: TEMPERATURE UNITS

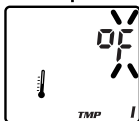

A highlighted thermometer icon indicates that the computer is in the Temperature Setup screen mode. The flashing "F" indicates Fahrenheit. To choose temperature readings that are displayed in the Fahrenheit scale, press Button #1 to select it and advance. To select the Celsius scale, press Button #2 to scroll to a flashing "C". Then press Button #1 to select and advance.

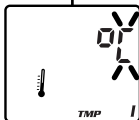

SETUP: CLOCK

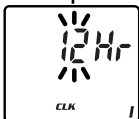

The V100A clock displays time in either a 12 or 24 hour format. A "PM" indicator appears only in the 12hr format. To select a format and set the current time, proceed as follows:



Step 1: Use Button #2 to toggle between the two time formats (the numbers will flash).



Step 2: Press Button #1 to select the desired time format and advance to the Clock Setup screen with the left hours digits flashing.



Step 3: To set the current time, press Button #2 to advance the flashing digit, then press Button #1 to select it and advance to the next flashing digit.

Step 4: Repeat this procedure for each digit until the correct time is set in hours and minutes, then press Button #1 again to select and advance. **Note:** Although there is only one clock time, either time format-12 or 24 hour-can be set for bikes I and II.

SETUP: ODOMETER



Bike I and Bike II have separate, programmable odometers. On a new computer the Odometer screen should read "00000" for both. To confirm this initial zero setting, simply press Button #1 successively to select each flashing digit and advance to System Check. To reenter mileage achieved after a battery change, follow these steps:

- Step 1:** When the far right digit begins to flash, press Button #2 to scroll to the desired number.
- Step 2:** Press Button #1 to select this number and advance to the next flashing digit.
- Step 3:** Repeat this procedure for each digit until the correct mileage figure is displayed (99999 = maximum). When Button #1 is pressed to select the final digit in the sequence, the Odometer setting is completed and the computer automatically advances to the System Check screen.

SETUP: SYSTEM CHECK

After the Programmable Odometer is set, both the Initial and Normal Operating Mode Setup programs will automatically advance to the System Check screen sequence. System Check displays all value and unit settings chosen during Setup in a 6 screen sequence with the Altimeter "ON", or a 5 screen sequence with the Altimeter "OFF". Each screen in System Check appears for 5 seconds and will blink. When the review is complete, the computer automatically exits Initial Setup System Check and advances to the SPD/DST screen in Normal Operating Mode.

To change any values or correct any unit errors made during Initial Setup, you must re-enter the Setup program in NOM by pressing Buttons #1 and #2 simultaneously for 2 seconds in the SPD/DST screen mode with the RT/TT timers deactivated.

Note: System Check is activated in two ways: A) Automatically at the end of either Initial or NOM Setup and B) By pressing Button #3 at any time during NOM Setup. To exit System Check manually in NOM Setup, press Button #3 to return to the SPD/DST primary screen mode.

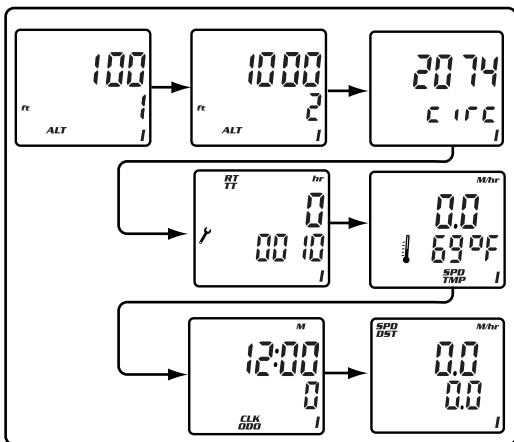

PRE-RIDE ALTIMETER CALIBRATION SETUP

INTRODUCTION

Before any new ride, the V100A Altimeter must be recalibrated so that it "knows" the correct starting elevation. Because elevation is calculated via barometric pressure, changes in barometric pressure detected by the sensor change the elevation displayed on the ALT/% screen. Barometric pressure falls as elevation increases and rises as elevation decreases.

To ensure the accuracy of altitude data, recalibration of the V100A Altimeter is accomplished in two ways: A) By entering a known elevation for a current location or B) By entering the current, local barometric pressure at sea level for that moment in time. A known elevation reading can be A) Recalled from either of 2 elevations stored in Altimeter Memory 1 and 2, or B) Entered manually, based on a current location in feet or meters. Or, the user may find out the current local barometric pressure reading from a local airport, weather service bureau or online from an internet source such as www.noaa.com or yahoo weather at www.yahoo.com.

PRE-RIDE ALTIMETER CALIBRATION

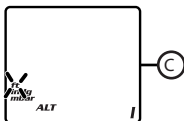
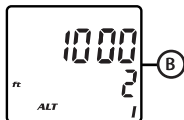
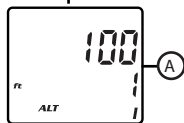

To calibrate the Altimeter, access the Pre-Ride Altimeter Calibration Setup program in NOM from the ALT/% screen. Press both Buttons #1 and #2 simultaneously for 2 seconds to enter the Setup screens for Altimeter Calibration. **A)** The first screen shows the Memory 1 Altimeter setting. Press Button #1 to select that altitude setting, or **B)** Press Button #2 to advance to the Altimeter Memory 2 setting and press Button #1 to select. Or, **C)** Press Button #2 again to advance to the Manual Altimeter Calibration screen. Press Button #1 to advance to the Manual Elevation Setting. On the upper line the digits "00000" will appear with the right digit flashing. A known elevation may be entered in this screen by pressing Button #2 to increase the flashing digit to the desired number (in feet or meters). Press Button #1 to select the correct digit and advance. Continue to enter numbers in this manner to reach the current elevation (pre-ride) until the entry is complete, then press Button #1 to select it and return to the (newly calibrated) ALT/% screen.

BAROMETRIC CALIBRATION

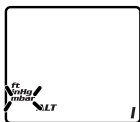
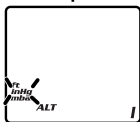

The V100A Altimeter may also be calibrated by entering the current, local, barometric pressure at sea level either in Inches of Mercury (inHg) or in Millibars (mbar). To access the barometric entry screens, press Button #2 to bypass the Manual Altimeter Elevation input screen (See point C above). The letters "inHg" will then appear and start to flash. If you wish to enter barometric pressure in Inches of Mercury, press Button #1 to select that unit of pressure and advance to the inHg calibration screen. Use Button #2 to advance the digits to the correct number and press Button #1 to select and advance. When all the digits for the inHg units have been entered, press Button #1 to select that setting and advance to the ALT/% screen.

If, however, you wish to enter barometric pressure in Millibars (mbar), press Button #2 while "inHg" is flashing to scroll to the Millibars calibration screen with the letters "mbar" flashing. To enter the current pressure in Millibars, press Button #1 to select that setting and enter the digits as instructed above. **Note:** Once you have set a barometric pressure and selected it by pressing Button #1, the computer will automatically convert the pressure reading to an elevation (in feet or meters) and exit Altimeter Calibration Setup to the ALT/% screen.

PERCENT GRADE

VETTA uses a barometric sensor to gauge the (noise) changes in the air pressure which does not update constantly; this is why sometimes you may get varying readings due to weather changes, fast ascents and descents or not enough change in altitude i.e. small rolling hills.

These are some of the other guidelines you can use to improve the accuracy of readings.

- It will take at least a 20-30m distance (depending on the pressure sensor) before it starts to output a gradient reading even for steep slope (say over 10%).
- It will output a gradient reading of a slope which vertical displacement is larger than 3-5m. i.e. it will display zero gradient if the vertical displacement of the short slope is less than 3m in height.
- For the same reason as above, the V100A may display zero or higher gradients; if the user climbs a short slope followed by descending another short slope.
- If you are looking for what we call a real-time altimeter, the most accurate way is GPS. Otherwise most altimeters use a very sensitive pressure sensor that measures the changes in the air pressure.

V100A Cycle Computer will output and update Percent Grade (%) of uphill or downhill when the vertical displacement is greater than 3 meters.

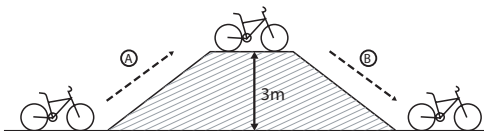

Example:

2% Gradients:

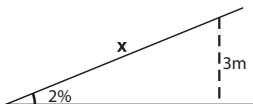

Trip Distance Required, $x=150$ meters

5% Gradients:

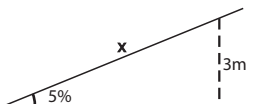

Trip Distance Required, $x=60$ meters

10% Gradients:

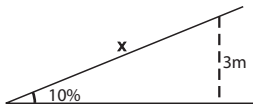

Trip Distance Required, $x=30$ meters

INSTALLATION

WIRED MODEL INSTALLATION

SPEED SENSOR & MAGNET

NOTE: Wired cadence is optional. Please refer to WIRED SPEED AND CADENCE/WL2X DOUBLE WIRELESS SPEED AND CADENCE MANUAL for installation.

- Step 1:** Use the zip-tie supplied to hold loosely the wired speed sensor and mounting pad to the inside of either fork leg. We recommend mounting it as high up on the fork leg as possible to protect it from being hit by rocks, branches or other objects while riding. (Fig. 1)
- Step 2:** Tighten the spoke magnet to any spoke on the "sensor side" of the front wheel so that it passes over the alignment mark on the sensor. (Fig. 1, 2)
- Step 3:** Attach the alignment setup spacer to the magnet temporarily. (Fig. 3)
- Step 4:** Slide and rotate the sensor until the alignment mark just touches the spacer tip on the magnet. (Fig. 4)
- Step 5:** Route the sensor wire up the fork blade and secure it with the tape. Wrap excess wire around the front brake cable housing, leaving enough slack to attach the mounting bracket easily to the handlebar and allow for movement of the bar and stem. **CAUTION: When installing the speed sensor on a suspension fork, make sure that the fork is fully extended to ensure there is enough wire to reach the mounting bracket properly. Excess sensor wire should be taped down or wrapped around the brake cable housing for safety.**
- Step 6:** Snug the zip tie down to hold the sensor in its final position.
- Step 7:** Remove the spacer and verify that the magnet and sensor spacing stayed the same. (Fig. 5)

Note: Do not use a zip-tie tightening tool or a third hand tool when doing the final tensioning of the zip-ties. This can tear and damage the sensor or transmitter.

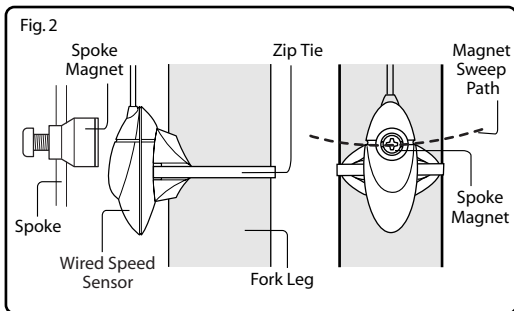
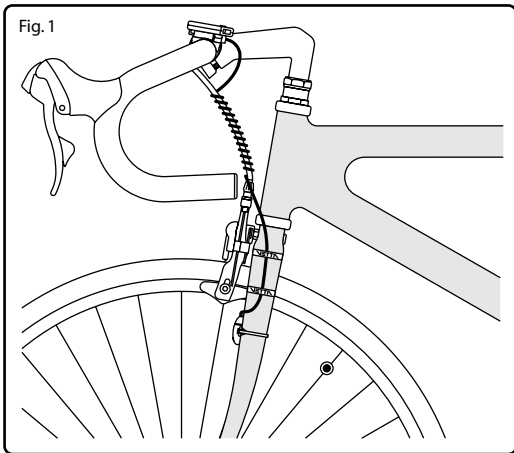

Fig. 3

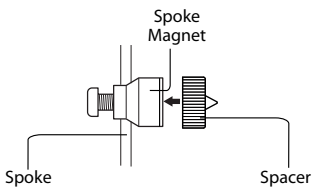

Fig. 4

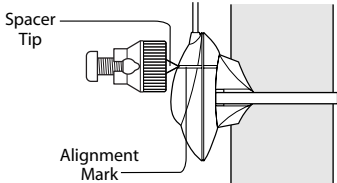
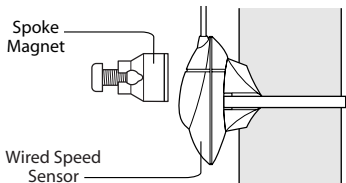
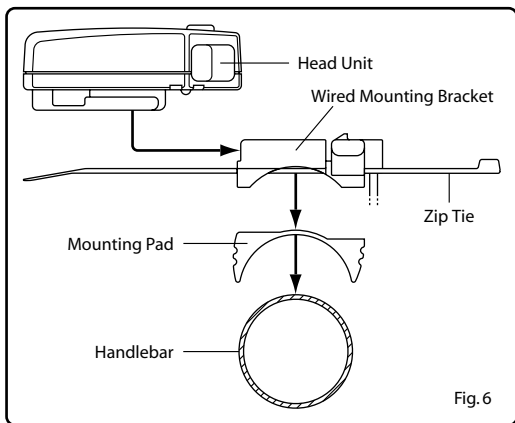

Fig. 5



MOUNTING BRACKET



- Step 1:** Install mounting pad and wired mounting bracket to the handlebar using the 2 zip ties provided. (Fig. 6)
- Step 2:** Tighten the zip ties so that the mounting bracket holds its position on the bars yet can be easily adjusted. (Fig. 7) Trim excess. **CAUTION: Do not use zip ties but tapes provided to hold wires to the frame, fork, bars or stem to avoid damaging or cutting the wires accidentally.**

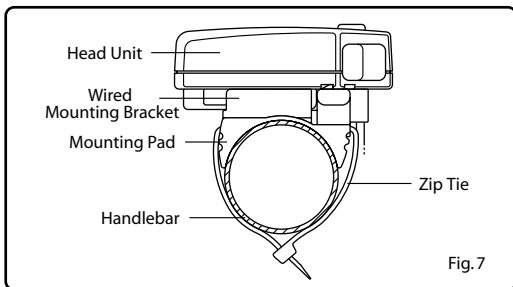

HEAD UNIT

The V100A head unit is designed to slide into the mounting bracket from the front to the back and lock into position. You should hear an audible "**CLICK**" when the head unit has been properly locked into position. This indicates proper alignment between the computer head pins and the mounting bracket contacts. To remove the computer head from the bracket, gently pinch the two locking tabs inward and slide the head unit forward and out of the bracket. (Fig.8)

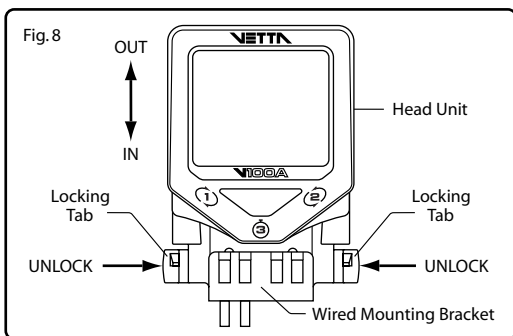

WIRELESS MODEL INSTALLATION

SPEED TRANSMITTER & MAGNET

NOTE: WL2X Double wireless Speed & Cadence is optional. Please refer to WIRED SPEED AND CADENCE/WL2X DOUBLE

The V100A is designed to operate as a wireless unit with the installation of a special active mount and WL wireless speed transmitter.

- Step 1:** Use the zip-ties supplied to hold loosely the wireless speed transmitter and mounting pad to the left fork leg.
Note: To maximize signal reception, position the transmitter as high up on the fork leg as possible. (Fig. 9)
- Step 2:** Tighten the spoke magnet to any spoke on the "transmitter side" of the front wheel so that it passes over the alignment mark on the transmitter. (Fig. 9, 10)
- Step 3:** Attach the alignment setup spacer to the magnet temporarily. (Fig. 11)
- Step 4:** Slide and rotate the transmitter until the alignment mark just touches the spacer tip on the magnet. (Fig. 12)
- Step 5:** Snug the zip ties down to hold the transmitter in its final position.
- Step 6:** Remove the spacer and verify that the magnet and transmitter spacing stayed the same. (Fig. 13)

Fig. 9

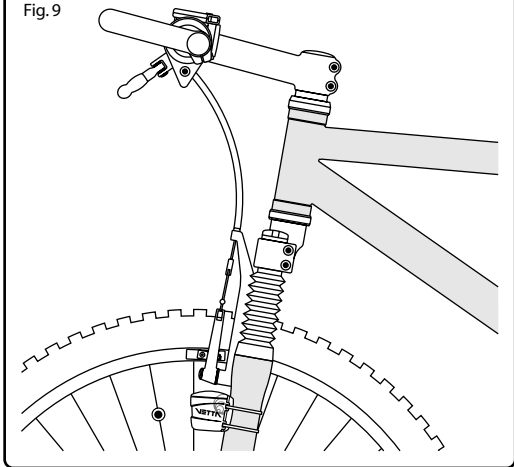

Fig. 10

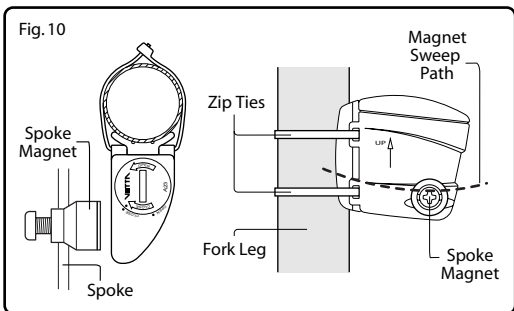

Fig. 11

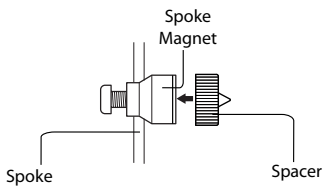

Fig. 12

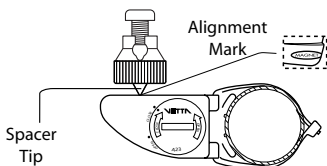
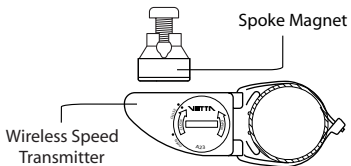
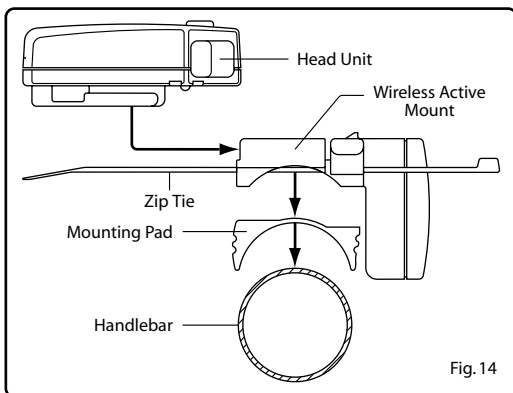

Fig. 13



ACTIVE MOUNT

Attach the active mount and mounting pad to the handlebar. Adjust its position to your liking and tighten the zip ties. (Fig. 14, 15)



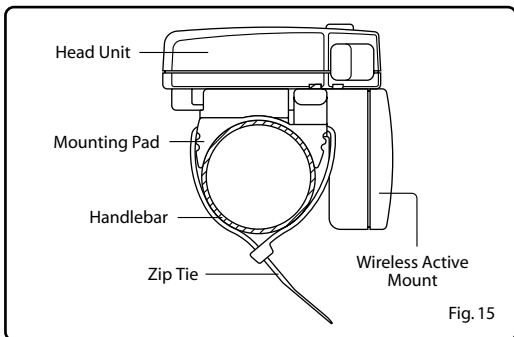

HEAD UNIT

The head unit is designed to slide into the wireless active mount from the front to the back and lock into position. You should hear an audible **"CLICK"** when the head unit has been properly locked into position. This indicates proper alignment between the computer head pins and the active mount contacts. To remove the computer head from the mount, gently pinch the two locking tabs inward and slide the head unit forward and out of the mount. (Fig. 16)

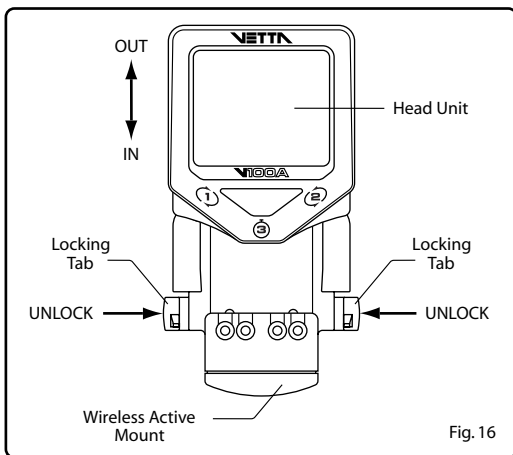

INSTALLATION TESTS

Once installation is complete, the computer should be tested to make sure it is working properly.

Step 1: Advance the computer to the SPD/DST screen mode using Button #2.

Step 2: Pick up the front of the bicycle and spin the front wheel. The computer should display a speed reading within 2-3 seconds.

If there is no speed reading, make sure the timers (RT/TT) are running, check the alignment and spacing between the magnet and sensor or transmitter and make sure that the head unit is completely snapped into position. If these checks do not solve the problem, talk to an Authorized Vetta Retailer or connect to www.vetta.com.

IMPORTANT: Following the installation tests above, make sure that the spoke magnet locking screw and all zip ties are properly tightened.

Tips: Rotating the angle of the transmitters or the handlebar receiver (slightly), can sometimes improve the signals being sent and received. Some bicycles have unusual frame tubes and angles, so by adjusting the components, can aid in trouble shooting by aligning the misdirected signals.

TROUBLESHOOTING

PROBLEM/ITEMS TO CHECK/SOLUTION

- **Current speed reading is erratic or does not appear.**
Check the alignment of the spoke magnet and sensor, and the distance between the two components. Realign the magnet and sensor with the spacer. Check to be sure RT and TT are activated.
- **Current speed reading is erratic or does not appear.**
Inspect the wiring for any breaks or kinks. Replace the mounting bracket and sensor as needed.
- **Incorrect data appears on screen during operation.**
Accuracy of the Setup data may be a problem (wheel circumference setting, bike #, etc.). Review data in System Check mode and revise as needed.
- **Altimeter reading is "wrong".**
Altimeter needs to be re-calibrated. See sections in Setup for instructions on how to recalibrate the Altimeter through elevation or barometric pressure settings. **IMPORTANT: The Altimeter must be re-calibrated before every ride.**
- **Data display is extremely slow.**
Computer LCD does not operate well in extremely low temperatures. Operating range is: 0°C to 50°C or 32°F to 122°F. Return computer to warmer climate.
- **Screen is dark and display characters look "strange".**
Computer screens are adversely affected if left in direct sunlight for extended periods of time. Move the computer into the shade until the screen recovers. No effect on data.

- **Screen reading is weak or fading.**
Symptom of interference or a weak battery.
Replace the battery.
- **Screen readings are erratic and read too high or too low.**
Symptom of a weak battery.
Replace the battery.
- **Screen "frozen", no response to buttons.**
Symptom of a weak battery.
Replace the battery.
- **No display whatsoever.**
Battery is completely dead, or not installed.
Replace or install the battery.

TECHNICAL SPECIFICATIONS

Current Speed (SPD)	0.0~120.0 KM/hr; 0.0~75.0 Mi/hr; +/-0.1 KM/hr or Mi/hr. Updated once per second.
Average Speed (AVG)	0.0~120.0 KM/hr; 0.0~75.0 Mi/hr; +/-0.1 KM/hr or Mi/hr. Updated once every 0.1 Miles or Km traveled.
Maximum Speed (MAX)	Limit: 120.0 KM/hr; 75.0 Mi/hr.
Odometer (ODO)	0~99999 km or miles.
Trip Distance (DST)	0.0~999.9 km or miles; +/- 0.1 km or mi.
Temperature (TMP)	Range: 0°C~49°C or 32°F~120°F; +/- 1°C or °F.
Altimeter (ALT)	Range: -1000 to 4500 feet or - 303 to 1364 meters; +/- 10 feet or 3 meters.
Barometer	Range: 25.00 to 32.99 inHg or 800 to 1099 mbar.

Clock (CLK)	12 or 24 hour format, hours and minutes displayed.
Service Timer	Limit: 1~1999 hrs. max; +/- 1 hr.
Stopwatch (STP)	Limit: 9:59:59 (10 hrs.); +/-1.0 seconds.
Intermediate Distance (ID)	Range: 999.9 km or miles.
Intermediate Altitude (IA)	Range: 99999 feet or meters
Ride/Total Time (RT/TT)	Limit: 9:59:59 (10 hours) displayed in hr/min/sec. After 9:59:59, display restarts at "0:00:00".
Cadence (RPM) (optional)	Range: 15~255 RPM; +/- 1 RPM.
Power Supply	Head Unit: CR2032 3 volt battery. WL Wireless Speed Transmitter: A23 12 volt battery.
Battery Life	Head Unit: Wired: 260 days Wireless: 150 days WL Wireless Speed Transmitter: 180 days (1 hour training /day)

WARRANTY POLICY

ACUMEN INC. WARRANTS ALL **VETTA** (The Company) PRODUCTS AGAINST MANUFACTURER DEFECTS FOR A PERIOD OF 3 YEARS. Subject to the following limitations, terms and conditions, components will be free of manufacturing defects in materials and workmanship. The 3 year limited warranty is conditioned upon the components being used and operated in normal riding conditions. **This warranty does not cover normal wear and tear (i.e. battery replacement, broken wire...), rider abuse, acts of God, improper installation or product alteration. This warranty is void if the components were not purchased (new) from or through an authorized VETTA retailer or dealer; examples of unauthorized dealers are online auction sites or online retailers that do not offer service.**

ACUMEN INC. at its sole discretion will repair or replace items at its own cost. Users are responsible for all return freight shipping charges; when returning items for warranty service.

ACUMEN INC. will pay freight when returning serviced items, via USPS or UPS to consumers or dealers; once the item(s) has been repaired or replaced.

REQUIREMENTS FOR WARRANTY SERVICING

1. Prior to shipping an item back, you must first obtain a Return Authorization Number (s) (RA#). Each item being returned must have an individual RA#.
2. To obtain an RA #, you must either contact the retailer where the product was originally purchased from, or contact **VETTA** directly at customerservice@vetta.com.
3. For trouble shooting purposes, we request that the complete unit with packaging be returned to **ACUMEN INC.** unless otherwise stated by **VETTA** representative.

TEMS TO BE INCLUDED IN RETURNS

1. The defective product(s)
2. A letter clearly stating the problem(s) with the returned item(s).
3. Copy of the original sales receipt showing proof of purchase date.
4. The Company is not responsible for loss or additional damages while in transit to **ACUMEN INC.**
5. Clearly mark the RA# on the outside of the return packaging.
All items without an RA # will be refused and returned to the return address on the package.

The Company shall not be held responsible to replace items with new items for greater than the amount of the original item purchase price. This limited warranty does provide the original owner with certain legal rights and recourse. The original owner may possess other rights or recourse, depending on the state or country. Please check the web to help answer any question and service manual.

Acumen Inc.

**101A Executive Dr., Suite 100,
Sterling, VA 20166, USA.**

E-Mail: customerservice@vetta.com

Website: www.vetta.com