Introduction To AVID Product



By Charles Ko
05/14/2004

AVID Product Overview

Disc Brake

(05-5009-xxx-xxx)

Juicy 5, Juicy 7, BB 5, BB 7



Rim Brake

(05-5109-xxx-xxx)

SDG, SDG 5, SDG 5R, SDG 5RW, SDG 7, SDG SL
Shorty 4, Shorty 6, Arch Rival



Lever

(05-5209-xxx-xxx)

FR5, SPD 7, SPD SL



AM Goods

RMJ, FMJ, SJ, FJ



Juicy 5 & Juicy 7

Juicy 5 & 7 are both Hydraulic disc brake. The components of completely product must include **Lever, Caliper, Hose, Bracket, Rotor & Rotor Bolts**. Customer might choose different type with change these components exclude lever & caliper.

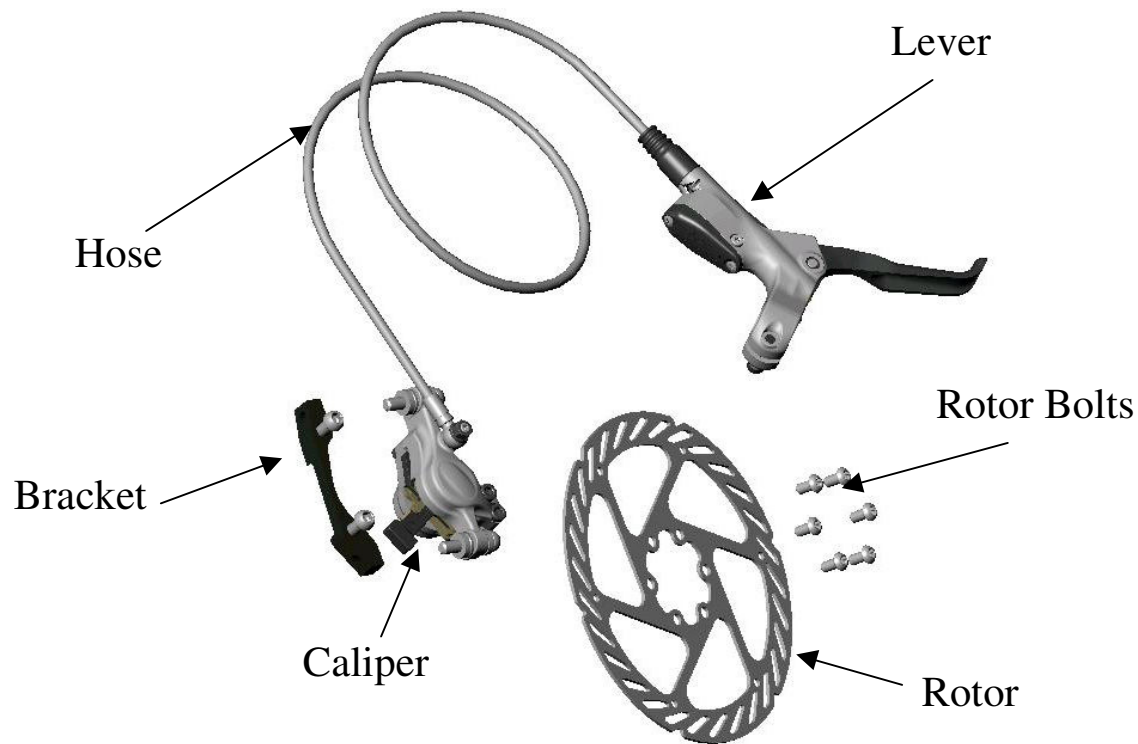

Juicy 5



Juicy 7

Lever

In Juicy 5 & 7, the lever for right & left side is the same except the screwing direction of clamp bolt. Sometimes, the normal assembly is left lever with front caliper, and right lever with rear caliper, however, there are exception, too.

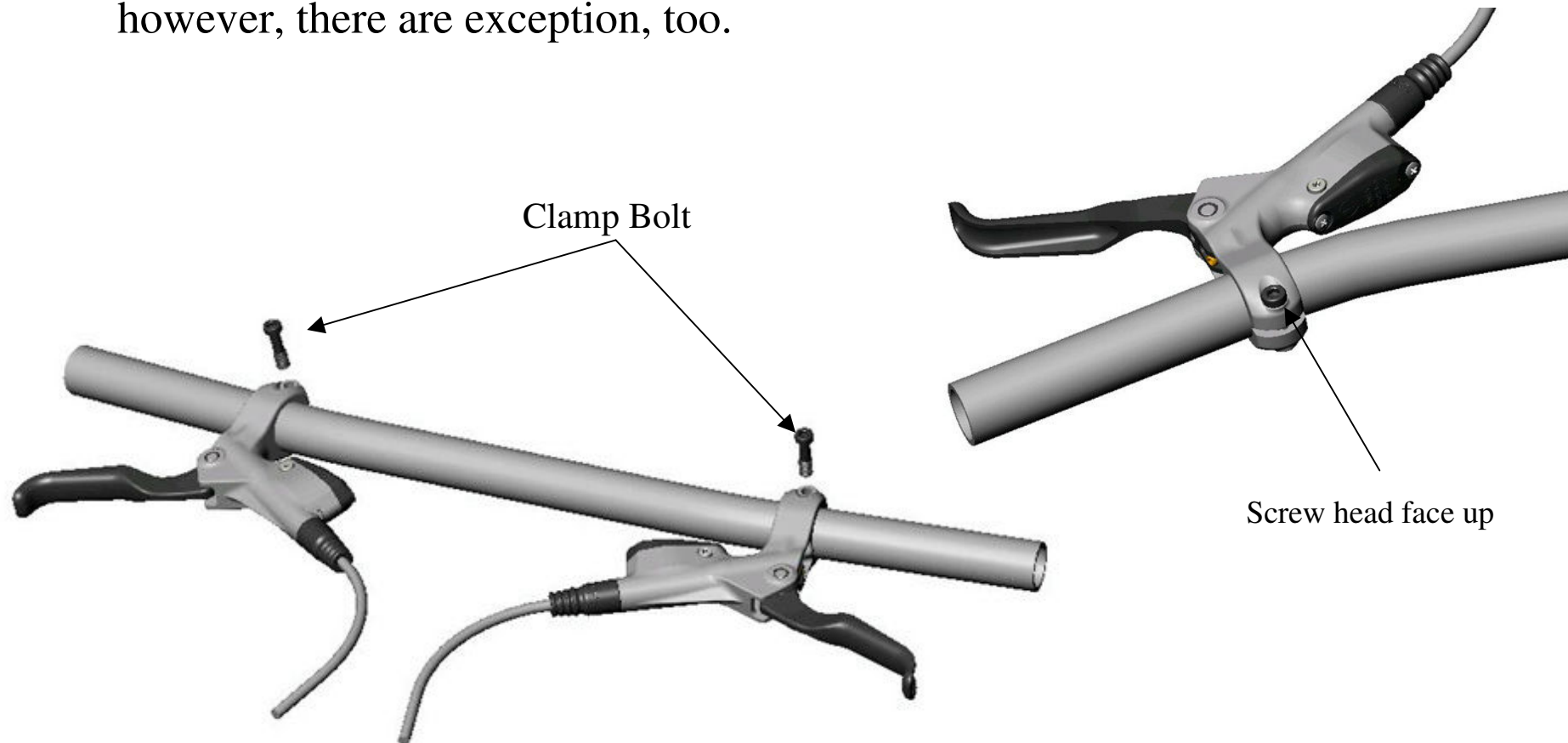

Rotor

AVID has 4 type & 3 dimension on rotor

Polygon: 160/185/203, only use on Juicy 7 for replacing Wavy

Clean Sweep: 160/185/203, use on BB5, BB7, Juicy 5

Roundagon: 160, only use on BB5

Wavy: 160, only use on Juicy 7

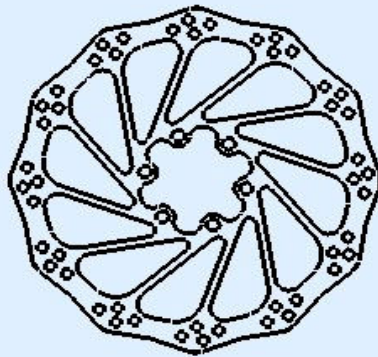

Polygon 160

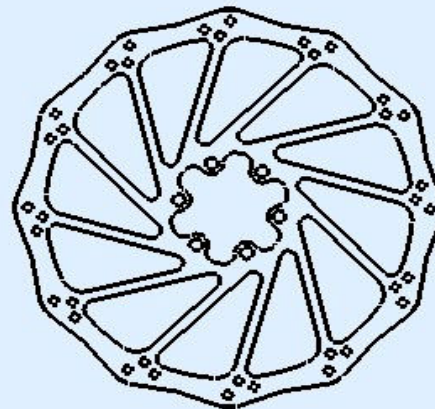

Polygon 185

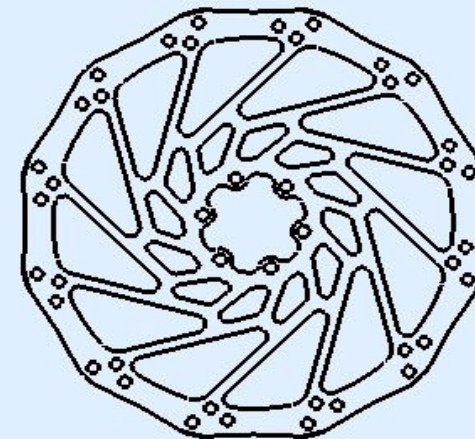

Polygon 203

Bracket

The Bracket classification depends on:

Type: Post & IS

Rotor: 160/185/203

Position: Front & Rear

Process: Forged & Extruded



Post Mount



International Standard - Front



International Standard - Rear

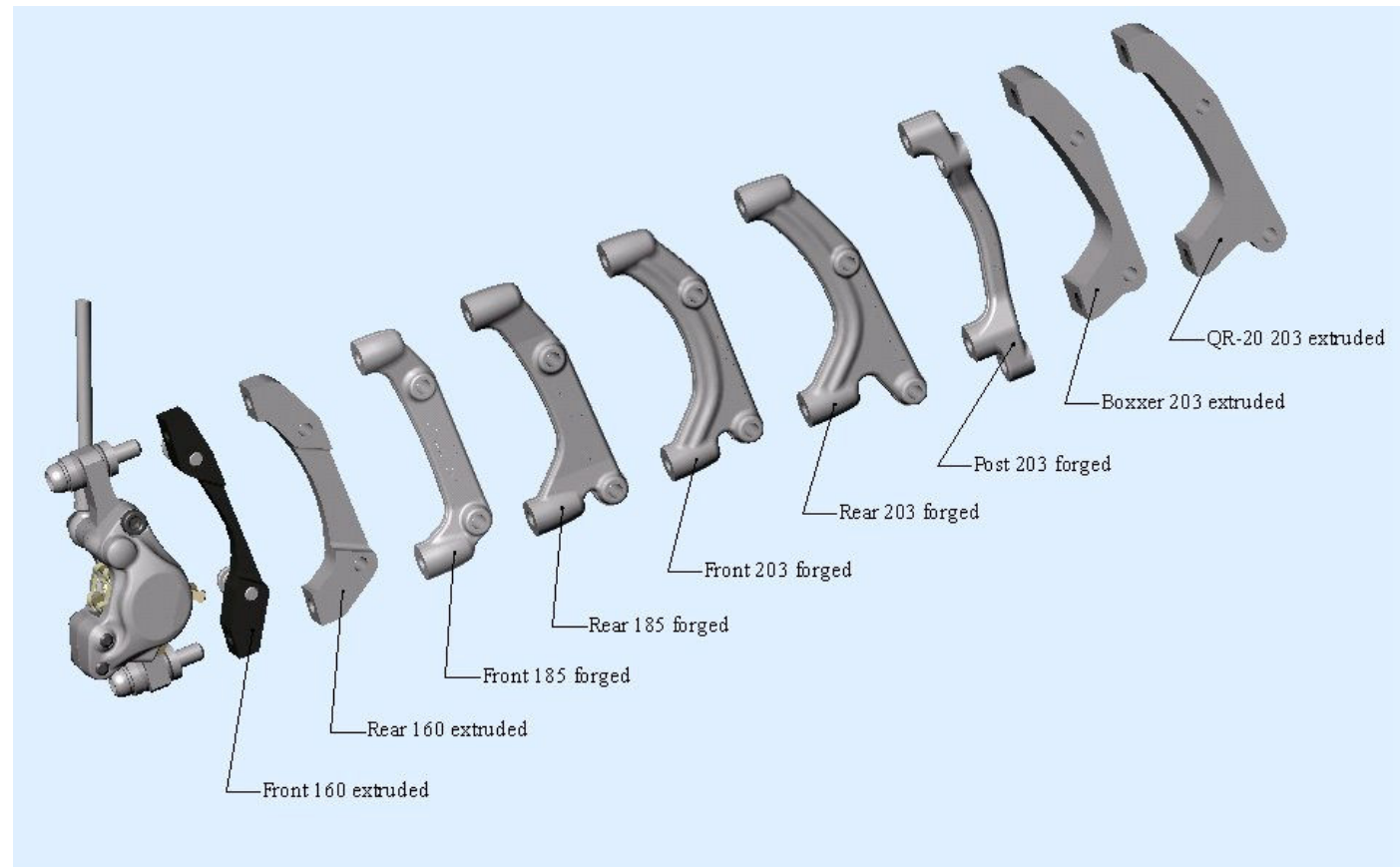

SAP Explanation

05-5009-288-010

OE, 05, DB, JUICY 5, **LEFT**, **FRONT**, **160**, **IS**, **700MM**

OE, 05, DB, Juicy 5: Juicy 5, Disc Brake, MY05

LEFT: Lever position, Left or Right

FRONT: Caliper position, Front or Rear

160: Rotor size, 160/185/203

IS: Bracket type, IS or Post

700MM: Hose length

Realization to our SAP

* 05-5009-288-010// OE, 05, DB, **JUCY 5, LEFT, FRONT, 160, IS, 700MM**

SAP #	A	B	C	D	E
	Left/Right	Front/Rear	Rotor	Bracket	Length
05-5009-288-010	L	F	160	IS	700
05-5009-288-020	L	F	160	IS	750
05-5009-373-010	L	F	185	IS	750
05-5009-374-010	L	F	185	POST	750
05-5009-288-030	L	F	160	IS	800
05-5009-373-010	L	F	185	IS	800
05-5009-376-010	L	F	203	IS	800
05-5009-376-020	L	F	203	IS	850
05-5009-376-030	L	F	203	IS	900
05-5009-380-010	L	R	203	IS	1400
05-5009-380-020	L	R	203	IS	1450
05-5009-288-010	L	F	160	IS	700
05-5009-381-010	R	F	160	IS	700

BB 5 & BB7

As we have know the component of Hydraulic disc brake, it's easier to realize Mechanical disc brake, BB5 & BB7. The components of completely product only include **Caliper, Bracket, Rotor & Rotor Bolts**. Customer might choose different type with change Bracket & Rotor.

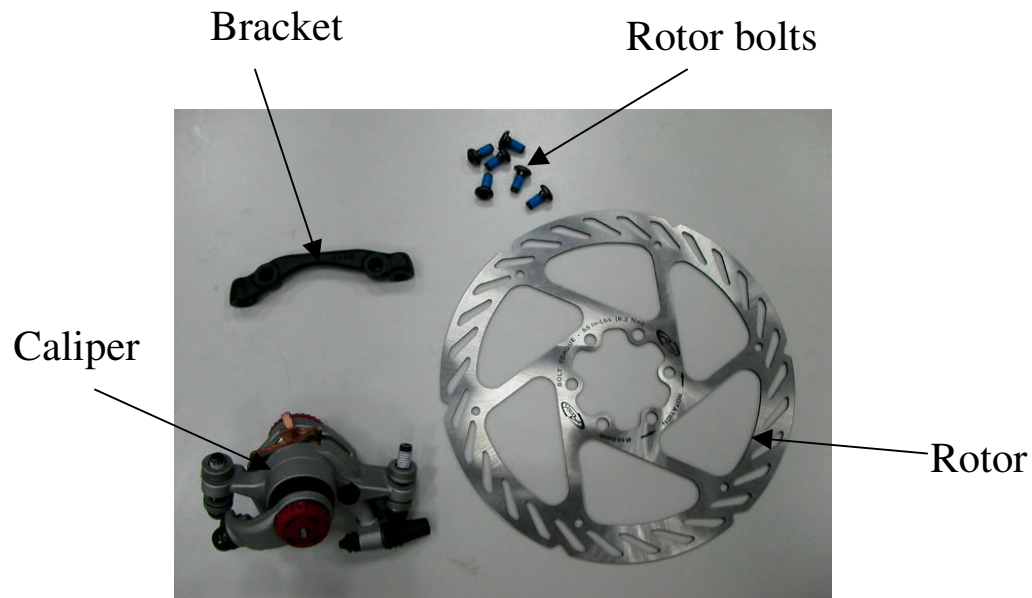

BB 7



BB 5

Comparison

	BB7 MTB	BB7 Road	BB5
Color	Gray	Silver	Gray
Pad Travel	Longer	Shorter	Shorter
Pad position adjustment	Both	Both	Single
Disc	Clean Sweep	Clean Sweep with "B"	Roundagon



BB7 - Road



BB 7 - MTB

Realization to our SAP

* 05-5009-405-000// OE, 05, DB, **BB5, FRONT, 160, IS**

SAP #	A	B	C	D
	Front/Rear	Rotor	Bracket	Type
05-5009- 405 -000	F	160	IS	-
05-5009- 411 -000	R	160	IS	-
05-5009- 407 -000	F	185	IS	-
05-5009- 409 -000	F	203	IS	-
05-5009- 405 -000	F	160	IS	-
05-5009- 406 -000	F	160	POST	-
05-5009- 414 -010	F	160	IS	MTB
05-5009- 425 -020	F	160	IS	Road

SDG & Arch Rival



SDG



SDG 5



SDG 5R



SDG 5RW



SDG 7



SDG SL

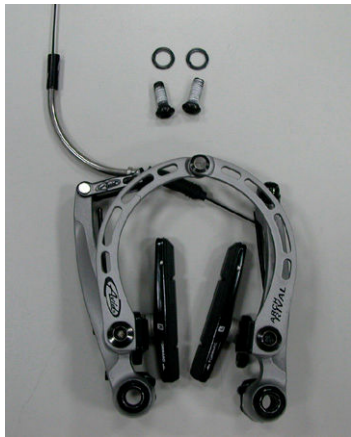

Arch Rival

SAP Classification

The classification in our SAP depends on:

- 1) Set up on **Front** or **Rear**
- 2) Noodle angle, **90/110/135**
- 3) Mounting Bolt, **16mm/25mm**
- 4) Interval between Pad & Arm (Washer),
4 In/6 In

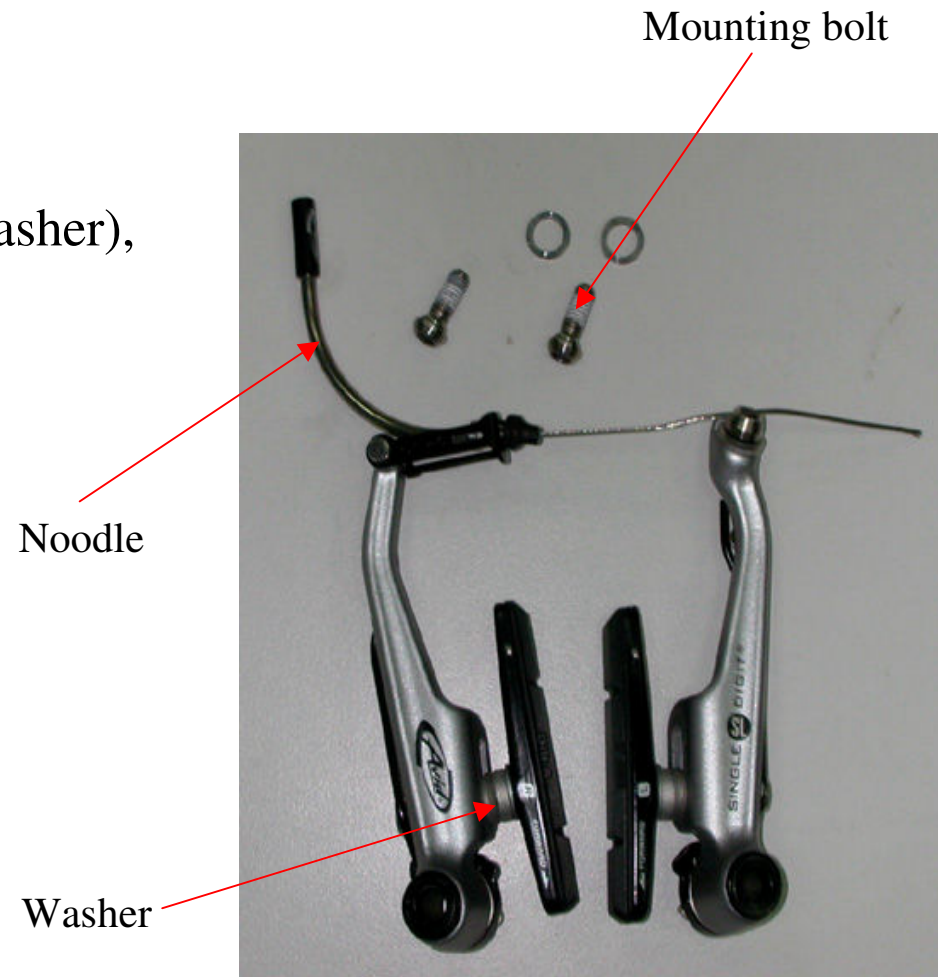

Pad assembly & Mounting Bolt

Some pads, as RW2, are being sorted by Right & Left since they are assembled to Holder with entry one side. To avoid breaking away from holder, always make sure the closed side face to wheel forward direction. Therefore, the pads need to be exchanged each other while changing mounting position, Front or Rear.

There are 2 length of Mounting Bolt as 16 mm & 25 mm.

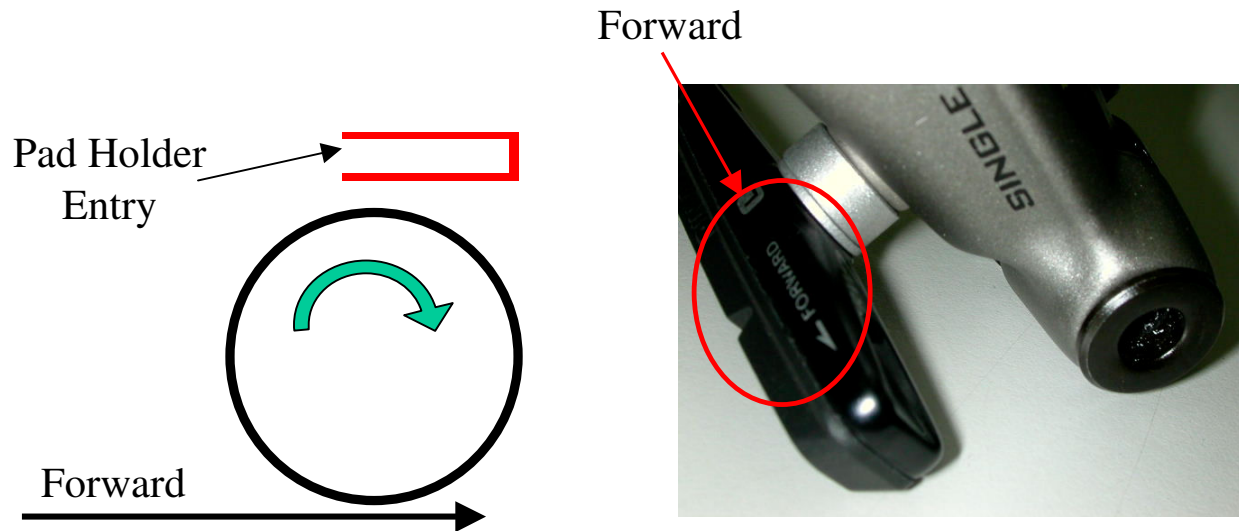

Interval between Pad & Arm

The arrangement of washers, concave, convex & flat, could build different interval between Pad & Arm.

“4 IN” in SAP description means the dimension of Inside is 4 mm.

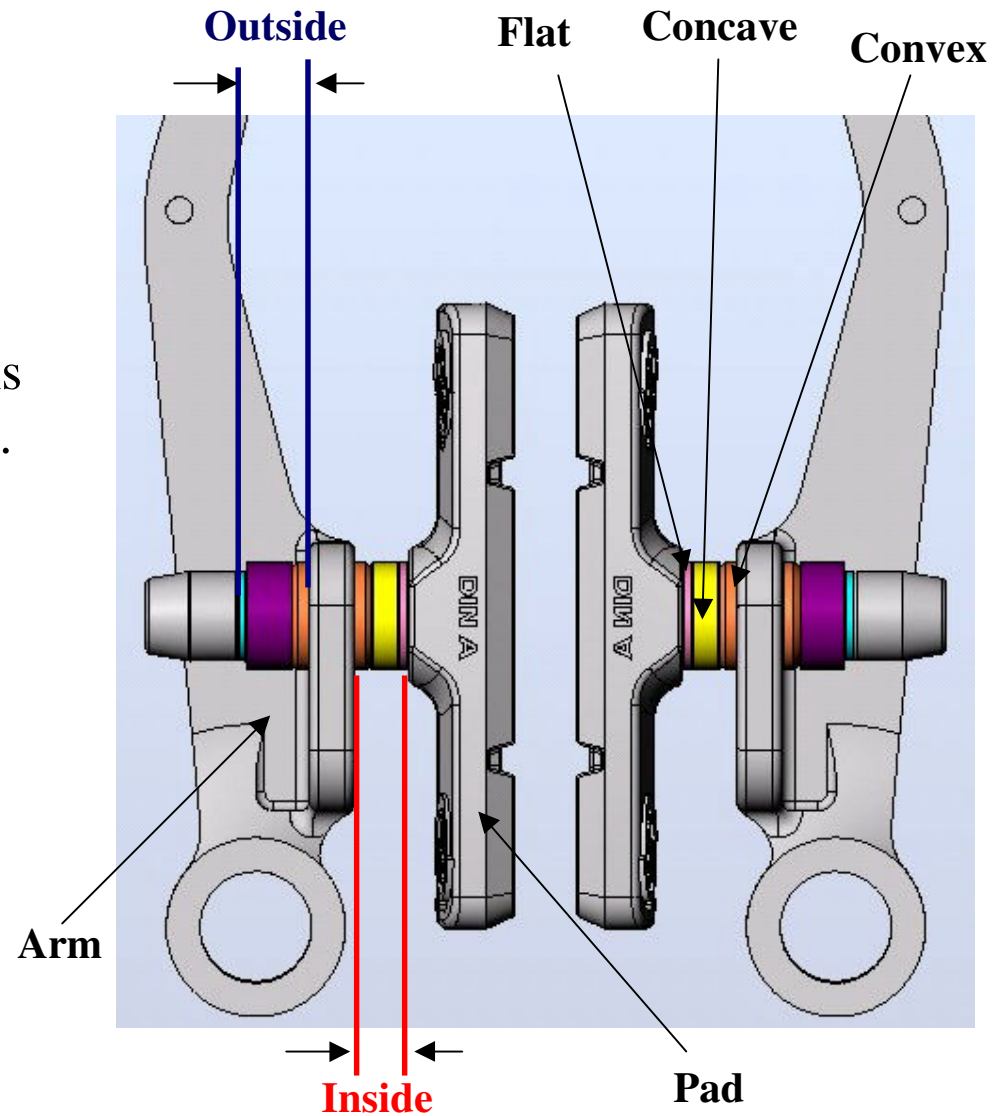

Noodle Angle

There are 3 types of Noodle with different angle, 90/110/135

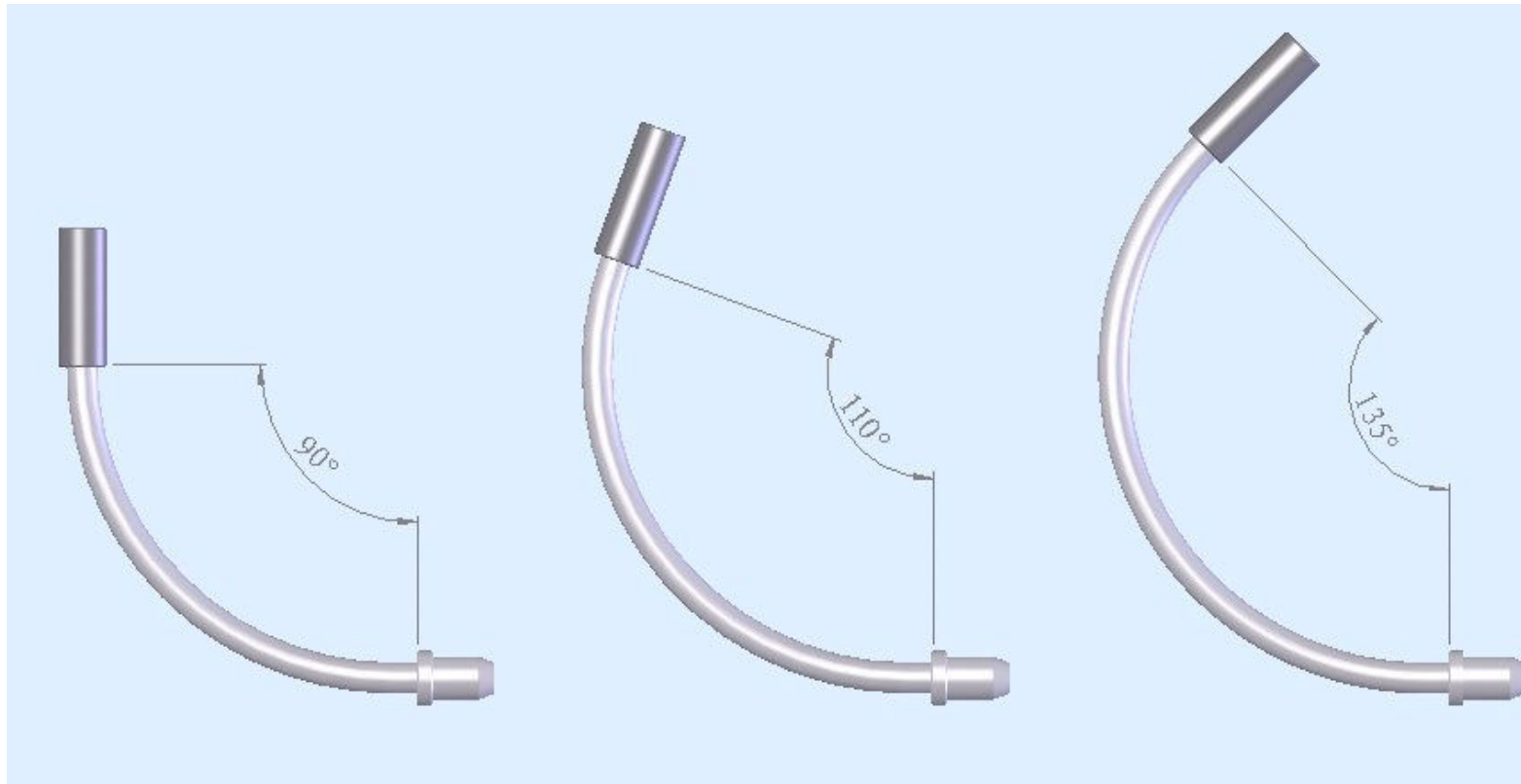

Explanation for SAP Classification

05-5109-371-010

OE, 05, RB, SD SL, **FRONT**, **16MM**, **4 IN**, **90**

OE, 05, RB, SD SL: SDG SL, Rim Brake, MY05

FRONT: Set up position, Front or Rear

16MM: Length of Mounting Bolt, 16mm/25mm

4 IN: Interval between Pad & Arm

90: Noodle angle

Realization to our SAP

* 05-5109-428-010// OE, 05, RB, SD 7, FRONT, 16MM, 4 IN, 90

SAP #	A	B	C	D
	Front/Rear	Bolt	Washers	Noodle
05-5109-428-010	F	16	4 IN	90
05-5109-428-020	F	16	6 IN	90
05-5109-430-010	R	16	4 IN	110
05-5109-430-020	R	16	4 IN	135
05-5109-430-030	R	16	4 IN	90
05-5109-430-040	R	16	6 IN	110
05-5109-430-050	R	16	6 IN	135
05-5109-430-060	R	16	6 IN	90
05-5109-428-010	F	16	4 IN	90
05-5109-429-010	F	25	4 IN	90
05-5109-428-010	F	16	4 IN	90
05-5109-430-010	R	16	4 IN	90

Shorty 6 & Shorty 4

AS one type of Rim Brake, Shorty also could be adjusted the interval between pad & arm by washers. The only different definition of classification with SDG series is the angle of link wire.



Shorty 6

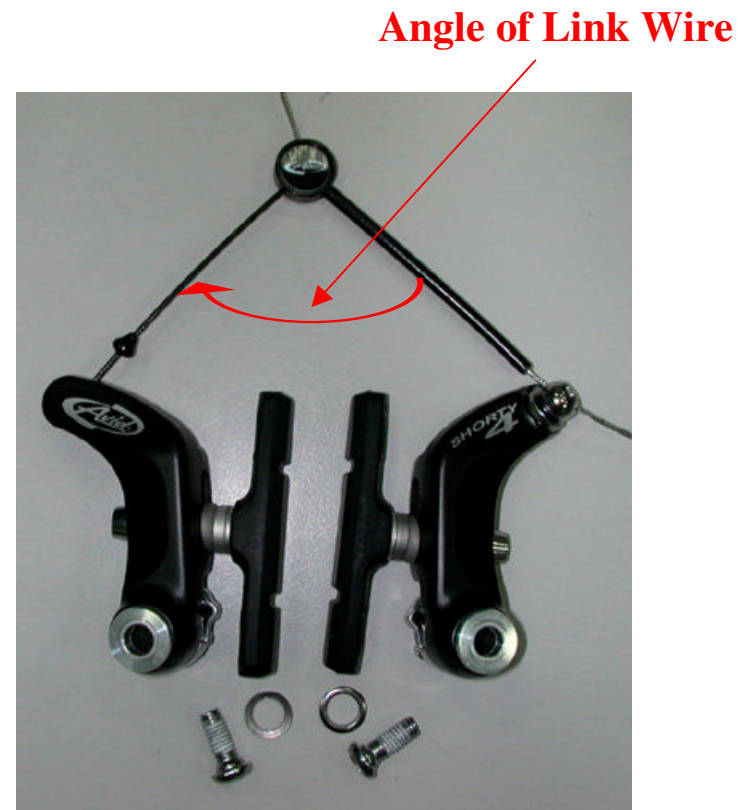

Shorty 4

Angle of Link Wire

The dimensions of A & B will decide the Angle C. In our SAP, we use A, B, C, D, S to indicate the different angle of 95, 85, 80, 90, 110.

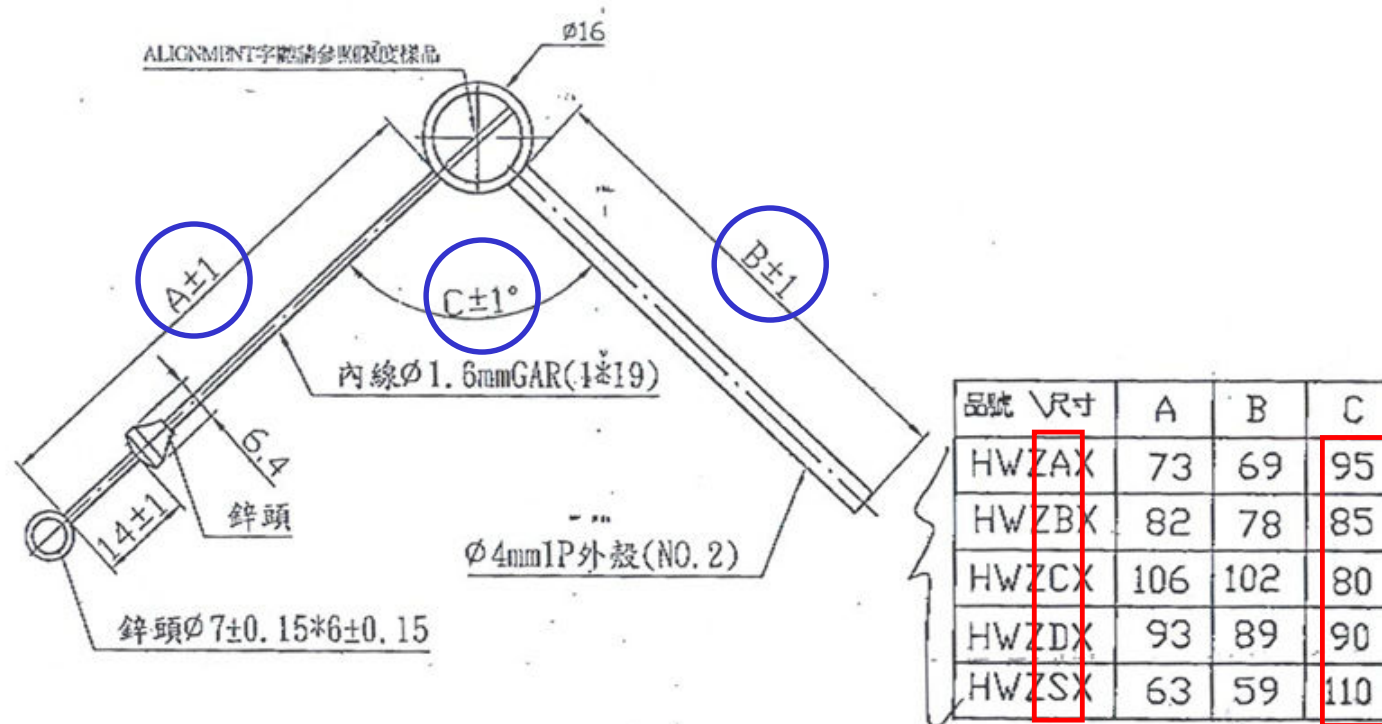

Explanation for SAP Classification

05-5109-447-010

OE, 05, RB, Shorty 6, **FRONT**, **4 IN**, **A**

OE, 05, RB, SD SL: SDG SL, Rim Brake, MY05

FRONT: Set up position, Front or Rear

4 IN: Interval between Pad & Arm

A: Angle of Link Wire

Realization to our SAP

- * 05-5109-446-010// OE, 05, RB, **SHORTY 4**, 4 IN, A
- * 05-5109-447-010// OE, 05, RB, **SHORTY 6, FRONT**, 4 IN, A
- * 05-5109-448-010// OE, 05, RB, **SHORTY 6, REAR**, 4 IN, A

SAP #	A	B	C
	Front/Rear	Washers	Link Wire
05-5109-447-010	F	4 IN	A
05-5109-447-020	F	4 IN	B
05-5109-447-030	F	4 IN	C
05-5109-447-040	F	4 IN	D
05-5109-447-050	F	4 IN	S
05-5109-447-010	F	4 IN	A
05-5109-447-060	F	6 IN	A
05-5109-447-010	F	4 IN	A
05-5109-448-010	R	4 IN	A

FR 5 & SPD

There are 3 type of AVID Lever in MY05. A general bicycle should has A Pair of levers. With symmetric design of FR5 & SPD lever body like Juicy 5 & 7, the right & left side is the same except the screwing direction of clamp bolt.



FR 5



SPD 7



SPD SL

Explanation for SAP Classification

There are only 6 types of lever for OE.

SAP #	Description
05-5209-337-010//	OE, 05, FG, BL, FR5, Left
05-5209-337-020//	OE, 05, FG, BL, FR5, Right
05-5209-338-010//	OE, 05, FG, BL, Speed Dial 7, Left
05-5209-338-020//	OE, 05, FG, BL, Speed Dial 7, Right
05-5209-339-010//	OE, 05, FG, BL, Speed Dial SL, Left
05-5209-339-020//	OE, 05, FG, BL, Speed Dial SL, Right

AM Products

We could sort AVID AM products by “FG AM” & “Replacement”.

FG AM

It means we sell complete product with AM package, as Disc Brake, RMJ, Grip, FMJ.

Replacement

It means we sell some parts or component of our FG, disc brake, rim brake, lever, etc., as Pad, bracket, rotor.

Now, There are about 156 item in AVID AM, and there are about 66 from Taiwan Vendors. The more detail info have post to SramDocs.

Total list: <http://10.1.6.3/dscgi/ds.py/View/Collection-9081>
(Denver_Warehouse_Inventory_Part_Numbers.xls)

Description: <http://10.1.6.3/dscgi/ds.py/View/Collection-9381>

AM Products



RMJ (091060)



FMJ (381001)



BB7 185 Front (741157)



RW2 Pad Green (737006)



Bracket Rear 203 (732025)

Appendix

Juicy

05-5009-288-010	OE, 05, DB, JUICY 5, LEFT, FRONT, 160, IS, 700MM
05-5009-288-020	OE, 05, DB, JUICY 5, LEFT, FRONT, 160, IS, 750MM
05-5009-288-030	OE, 05, DB, JUICY 5, LEFT, FRONT, 160, IS, 800MM
05-5009-288-040	OE, 05, DB, JUICY 5, LEFT, FRONT, 160, IS, 850MM
05-5009-372-010	OE, 05, DB, JUICY 5, LEFT, FRONT, 160, POST, 700MM
05-5009-372-020	OE, 05, DB, JUICY 5, LEFT, FRONT, 160, POST, 750MM
05-5009-372-030	OE, 05, DB, JUICY 5, LEFT, FRONT, 160, POST, 800MM
05-5009-372-040	OE, 05, DB, JUICY 5, LEFT, FRONT, 160, POST, 850MM
05-5009-373-010	OE, 05, DB, JUICY 5, LEFT, FRONT, 185, IS, 750MM
05-5009-373-020	OE, 05, DB, JUICY 5, LEFT, FRONT, 185, IS, 800MM
05-5009-373-030	OE, 05, DB, JUICY 5, LEFT, FRONT, 185, IS, 850MM
05-5009-374-010	OE, 05, DB, JUICY 5, LEFT, FRONT, 185, POST, 750MM
05-5009-374-020	OE, 05, DB, JUICY 5, LEFT, FRONT, 185, POST, 800MM
05-5009-374-030	OE, 05, DB, JUICY 5, LEFT, FRONT, 185, POST, 850MM
05-5009-375-010	OE, 05, DB, JUICY 5, LEFT, FRONT, 203, BOXXER, 800MM
05-5009-375-020	OE, 05, DB, JUICY 5, LEFT, FRONT, 203, BOXXER, 850MM
05-5009-375-030	OE, 05, DB, JUICY 5, LEFT, FRONT, 203, BOXXER, 900MM
05-5009-376-010	OE, 05, DB, JUICY 5, LEFT, FRONT, 203, IS, 800MM
05-5009-376-020	OE, 05, DB, JUICY 5, LEFT, FRONT, 203, IS, 850MM
05-5009-376-030	OE, 05, DB, JUICY 5, LEFT, FRONT, 203, IS, 900MM
05-5009-377-010	OE, 05, DB, JUICY 5, LEFT, FRONT, 203, POST, 800MM
05-5009-377-020	OE, 05, DB, JUICY 5, LEFT, FRONT, 203, POST, 850MM
05-5009-377-030	OE, 05, DB, JUICY 5, LEFT, FRONT, 203, POST, 900MM
05-5009-378-010	OE, 05, DB, JUICY 5, LEFT, FRONT, 203, QR20, 800MM
05-5009-378-020	OE, 05, DB, JUICY 5, LEFT, FRONT, 203, QR20, 850MM
05-5009-378-030	OE, 05, DB, JUICY 5, LEFT, FRONT, 203, QR20, 900MM
05-5009-379-010	OE, 05, DB, JUICY 5, LEFT, REAR, 160, IS, 1250MM
05-5009-379-020	OE, 05, DB, JUICY 5, LEFT, REAR, 160, IS, 1300MM
05-5009-379-030	OE, 05, DB, JUICY 5, LEFT, REAR, 160, IS, 1350MM
05-5009-379-040	OE, 05, DB, JUICY 5, LEFT, REAR, 160, IS, 1400MM
05-5009-380-010	OE, 05, DB, JUICY 5, LEFT, REAR, 203, IS, 1400MM
05-5009-380-020	OE, 05, DB, JUICY 5, LEFT, REAR, 203, IS, 1450MM
05-5009-381-010	OE, 05, DB, JUICY 5, RIGHT, FRONT, 160, IS, 700MM
05-5009-381-020	OE, 05, DB, JUICY 5, RIGHT, FRONT, 160, IS, 750MM
05-5009-381-030	OE, 05, DB, JUICY 5, RIGHT, FRONT, 160, IS, 800MM
05-5009-381-040	OE, 05, DB, JUICY 5, RIGHT, FRONT, 160, IS, 850MM

Appendix

BB

05-5009-405-000	OE, 05, DB, BB5, FRONT, 160, IS
05-5009-406-000	OE, 05, DB, BB5, FRONT, 160, POST
05-5009-407-000	OE, 05, DB, BB5, FRONT, 185, IS
05-5009-408-000	OE, 05, DB, BB5, FRONT, 185, POST
05-5009-409-000	OE, 05, DB, BB5, FRONT, 203, IS
05-5009-410-000	OE, 05, DB, BB5, FRONT, 203, POST
05-5009-411-000	OE, 05, DB, BB5, REAR, 160, IS
05-5009-412-000	OE, 05, DB, BB5, REAR, 185, IS
05-5009-413-000	OE, 05, DB, BB5, REAR, 203, IS
05-5009-414-000	OE, 05, DB, BB7, MTB, FRONT, 160, IS
05-5009-415-000	OE, 05, DB, BB7, MTB, FRONT, 160, POST
05-5009-416-000	OE, 05, DB, BB7, MTB, FRONT, 185, IS
05-5009-417-000	OE, 05, DB, BB7, MTB, FRONT, 185, POST
05-5009-418-000	OE, 05, DB, BB7, MTB, FRONT, 203, BOXXER
05-5009-419-000	OE, 05, DB, BB7, MTB, FRONT, 203, IS
05-5009-420-000	OE, 05, DB, BB7, MTB, FRONT, 203, POST
05-5009-421-000	OE, 05, DB, BB7, MTB, FRONT, 203, QR20
05-5009-422-000	OE, 05, DB, BB7, MTB, REAR, 160, IS
05-5009-423-000	OE, 05, DB, BB7, MTB, REAR, 185, IS
05-5009-424-000	OE, 05, DB, BB7, MTB, REAR, 203, IS
05-5009-425-000	OE, 05, DB, BB7, ROAD, FRONT 160 IS
05-5009-299-000	OE, 05, DB, BB7, ROAD, FRONT, 160, POST
05-5009-426-000	OE, 05, DB, BB7, ROAD, REAR 160 IS

Appendix

Rim Brake

05-5109-428-010	OE, 05, RB, SD 7, FRONT, 16MM, 4 IN, 90
05-5109-428-020	OE, 05, RB, SD 7, FRONT, 16MM, 6 IN, 90
05-5109-429-010	OE, 05, RB, SD 7, FRONT, 25MM, 4 IN, 90
05-5109-429-020	OE, 05, RB, SD 7, FRONT, 25MM, 6 IN, 90
05-5109-430-010	OE, 05, RB, SD 7, REAR, 16MM, 4 IN, 110
05-5109-430-020	OE, 05, RB, SD 7, REAR, 16MM, 4 IN, 135
05-5109-430-030	OE, 05, RB, SD 7, REAR, 16MM, 4 IN, 90
05-5109-430-040	OE, 05, RB, SD 7, REAR, 16MM, 6 IN, 110
05-5109-430-050	OE, 05, RB, SD 7, REAR, 16MM, 6 IN, 135
05-5109-430-060	OE, 05, RB, SD 7, REAR, 16MM, 6 IN, 90
05-5109-431-010	OE, 05, RB, SD 7, REAR, 25MM, 4 IN, 110
05-5109-431-020	OE, 05, RB, SD 7, REAR, 25MM, 4 IN, 135
05-5109-431-030	OE, 05, RB, SD 7, REAR, 25MM, 4 IN, 90
05-5109-431-040	OE, 05, RB, SD 7, REAR, 25MM, 6 IN, 110
05-5109-431-050	OE, 05, RB, SD 7, REAR, 25MM, 6 IN, 135
05-5109-431-060	OE, 05, RB, SD 7, REAR, 25MM, 6 IN, 90
05-5109-447-010	OE, 05, RB, SHORTY 6, FRONT, 4 IN, A
05-5109-447-020	OE, 05, RB, SHORTY 6, FRONT, 4 IN, B
05-5109-447-030	OE, 05, RB, SHORTY 6, FRONT, 4 IN, C
05-5109-447-040	OE, 05, RB, SHORTY 6, FRONT, 4 IN, D
05-5109-447-050	OE, 05, RB, SHORTY 6, FRONT, 4 IN, S
05-5109-447-060	OE, 05, RB, SHORTY 6, FRONT, 6 IN, A
05-5109-447-070	OE, 05, RB, SHORTY 6, FRONT, 6 IN, B
05-5109-447-080	OE, 05, RB, SHORTY 6, FRONT, 6 IN, C
05-5109-447-090	OE, 05, RB, SHORTY 6, FRONT, 6 IN, D
05-5109-447-100	OE, 05, RB, SHORTY 6, FRONT, 6 IN, S
05-5109-448-010	OE, 05, RB, SHORTY 6, REAR, 4 IN, A
05-5109-448-020	OE, 05, RB, SHORTY 6, REAR, 4 IN, B
05-5109-448-030	OE, 05, RB, SHORTY 6, REAR, 4 IN, C
05-5109-448-040	OE, 05, RB, SHORTY 6, REAR, 4 IN, D
05-5109-448-050	OE, 05, RB, SHORTY 6, REAR, 4 IN, S